

Afiscooter C

USER Manual

MANUFACTURED BY

AFIKIM ELECTRIC VEHICLES

Kibbutz Afikim, 15148, Israel
Tel:972-4-6756451; Fax: 972-4-6751456

WARNING

Read the User Manual carefully before operating **AFISCOOTER C**.
If you do not fully understand any part of this manual, please contact your dealer or any of our Service Centres.
Read this manual step by step, as injury or damage may occur from misuse!

WARNING

Electromagnetic Interference ("EMI") can cause powered vehicles to behave erratically, which could be dangerous to the user.
For your safety and protection, it is IMPERATIVE that you take time to read Chapter 10 ("EMI WARNING") before operating **AFISCOOTER C**.

Serial Number and Manufacturer's data are fixed at the front, on the plastic mud guard cover on the metal label of the **AFISCOOTER C**.
(See figure 1, page 21)

WARRANTY

AFIKIM ELECTRIC VEHICLES strives continuously to improve its products, their quality and reliability, in constant effort to ensure its customers' satisfaction as well as its place in the market.
Warranty for **AFISCOOTER C** is subject to your local distributor's warranty.

INFORMATION

Only licensed distributors of **AFIKIM ELECTRIC VEHICLE** are qualified to distribute technical information regarding the **AFISCOOTER C**
Further information than what is mentioned in this user manual i.e. technical updates, safety notices and others will be communicated by local distributor's that has up-to-date contact information with **AFIKIM ELECTRIC VEHICLES**
In case you identify faulty information, please contact your Local distributor

CE CERTIFICATION

The Afikim Electric Vehicles Ref. Registration Number with the Competent Authority (UK) Is: CA000292.

Our Authorized Representative with the Competent Authorities is:

*The Squire 12, Am Flughafen,
60549 Frankfurt am Main, Germany*

www.arazygroup.com

Phone: +49 69 95932-5090

Fax: +49 69 95932-5200

E-mail: germany@arazygroup.com

CONTENTS

CHAPTER 1 – OVERVIEW OF THE AFISCOOTER C (MAIN FEATURES)	5
CHAPTER 2 – SAFETY SYMBOLS FOR THE <i>AFISCOOTER C</i>	6
CHAPTER 3 – SAFETY INSTRUCTIONS for <i>AFISCOOTER C</i>	11
CHAPTER 4 – GENERAL DESCRIPTION OF THE <i>AFISCOOTER C</i>	21
CHAPTER 5 – ADJUSTMENT INSTRUCTIONS	23
CHAPTER 6 – OPERATING INSTRUCTIONS	24
6.1 GENERAL	24
6.2 LCD DISPLAY USE	26
6.3 DRIVING AND GENERAL USE	27
CHAPTER 7 – CHARGING	30
CHAPTER 8 – MAINTENANCE	31
CHAPTER 9 – STORAGE	35
CHAPTER 10 – TROUBLESHOOTING AND REPAIR	36
CHAPTER 11 – EMI WARNING	38
Appendix A – Specification Sheet	39

CHAPTER 1 – OVERVIEW OF THE AFISCOOTER C (MAIN FEATURES)

Congratulations on choosing the **AFISCOOTER C** as your electrically powered scooter. **AFISCOOTER C** is a scooter for elderly and disabled persons, and for fun and sport. Scooter classification: Class B in accordance with EN12184.

AFISCOOTER C is designed for a maximum occupant mass of up to 135kg (300 lbs, 3W) / 150kg (330 lbs, 4W).

AFISCOOTER C is designed for elderly and disabled persons. There is a certain level of motoric capability, visual ability and cognitive ability required in order to operate the scooter. It is recommended to consult with your physician to evaluate your ability to operate the scooter.

AFISCOOTER C is an indoor & outdoor scooter designed to work in normal environmental conditions from very cold temperatures (-30°C/-22°F) to very hot temperatures (+45°C/+113°F).

AFISCOOTER C will operate in light rain showers, but extended use is not recommended in heavy rain or snow.

AFISCOOTER C is easy to operate. The relatively large wheels allow the user to drive on unpaved roads, over moderately rough terrain and over obstacles as high as 5" (12 cm). Refer to Appendix A: Specification Sheet (Page 30) for the required tyre pressure.

AFISCOOTER C maximum safe slope is: 9° (16%). Do not attempt to climb\descend slopes that steeper than the scooters limitation.

The braking system stops the vehicle smoothly and within a short distance after the throttle control lever is released.

AFISCOOTER C is equipped with both front and rear shock absorbers to give the user a comfortable and smooth drive, even when using the vehicle on moderately rough roads. A standard handbrake is also provided for backup.

The seat is spacious and comfortable, and can be rotated for easy access (standard seats). It can be adjusted forward and backward. The seat can also be adjusted up and down by a technician.

All controls are conveniently mounted on the tiller and are simple to operate.

Under normal conditions, **AFISCOOTER C** can travel approximately 40 km (27 miles) before the batteries require recharging. The distance will be reduced if the scooter is used frequently on slopes, rough ground or to climb kerbs etc.

After reading through this entire manual and before using **AFISCOOTER C**, please perform a brief visual check of the scooter to make sure that there is no visible damage. If you have any questions or concerns, contact your dealer.

AFISCOOTER C was developed to use maintenance-free sealed batteries only.

A Maintenance Manual is available for trained technicians.

For visually impaired people a digital format of the User manual can be downloaded from our web site www.afiscooters.com

CHAPTER 2 – SAFETY SYMBOLS FOR THE *AFISCOOTER C*



WARNING! An authorized supplier or qualified technician must perform the initial setup of this scooter, and must perform all of the procedures in this manual.

The symbols below are used throughout this user's manual and on the scooter to identify warnings and important information. It is very important for you to read them and understand them completely.



WARNING! Indicates a potentially hazardous condition/situation. Failure to follow designated procedures can cause either personal injury, component damage, or malfunction.

On the scooter, this is a triangular black symbol.



MANDATORY! These actions must be performed as specified. Failure to perform mandatory actions can cause personal injury and/or equipment damage. On the scooter, this is a white square on a dark background.



PROHIBITED! These actions are prohibited. These actions must not be performed at any time or under any circumstances. Performing a prohibited action can cause personal injury and/or equipment damage. On the scooter, this is a black symbol with a circle and slash.



Please note and strictly adhere to the following Safety Instructions. Additional Warnings and Notices are printed in this user manual; it is imperative that you read carefully all chapters of this manual before operating the *AFISCOOTER C*. It is also advisable to refresh your memory by re-reading this manual periodically.



Get acquainted with *AFISCOOTER C* and its operational features before driving it.

Drive slowly (speed limit dial set to MIN) until you get used to *AFISCOOTER C*, its various functions, safety features and its braking capabilities and limitations.



Watch carefully for pedestrians and drive your *AFISCOOTER C* accordingly.

In crowded areas, always drive in half speed mode.

Drive only where permitted according to all applicable local laws and ordinances. *AFISCOOTER C* is 66 cm (26") wide. Take great care not to hit persons or any objects around the vehicle.



Never remove any of the *AFISCOOTER C* safety parts such as fenders, plastic covers or emergency brake lever.

Never remove any of the Warning labels. If any of the Warning labels is removed, gets worn off or painted over, etc. ask your dealer to supply you with a new label.



Never put your hands, fingers, or legs into any moving parts or under any protective cover, since moving parts and hot surfaces are under those covers.



When making adjustments (folding the seat back, adjusting the armrest, moving the seat forward or backward, adjusting the tiller distance), as well as when squeezing the throttle control lever or handbrake, always take care that your hands and fingers are not trapped between any of the moving parts.

When moving the tiller forward or backward, be careful not to trap your fingers in the mechanism.



Never load AFISCOOTER C with more than 135 kg (300 lbs, 3WHEELS) or 150 kg (330 lbs, 4WHEELS), depending on the model) total load (user weight and all other loads combined, including baskets).

The load in the rear basket must not exceed 8 kg (17.6 lbs).

The load in the front basket must not exceed 5 kg (11 lbs).

AFISCOOTER C is designed to carry ONE person only on the Single Seat model. Never operate it with an additional person on board, including a child.



Never inflate **AFISCOOTER C** tyres more than the manufacturer's recommended pressure, shown on the tyres.



Never use **AFISCOOTER C** on stairs.

Never try to go over an obstacle that is more than the maximum recommended slope angle and obstacle height given in the specification sheet. When driving over an obstacle, always drive so that the front of **AFISCOOTER C** is facing the obstacle.



If for any reason **AFISCOOTER C** does not stop when you release the throttle control lever, or takes longer to stop than it should (3 meters on a level surface), immediately use the handbrake to stop **AFISCOOTER C**, turn the main key switch to OFF, and contact your dealer.



Do not use **AFISCOOTER C** in heavy rain or extreme humidity, or at temperatures below -30°C (-22°F) or above +45°C (+113°F).



WARNING, surface temperatures may be high



The seat weighs 21 kg (46 lbs). Each battery weighs a minimum of 14 kg (31 lbs). The Power Unit weighs a minimum of 25 kg (55 lbs). Be careful when lifting the seat and the batteries. See instruction for lifting the seat and the batteries in Chapter 8: Maintenance, and Chapter 9: Troubleshooting and Repair. Always lift using your knees and legs, not your back.



If the **AFISCOOTER C** is involved in any kind of an accident in which parts are damaged, you must get a qualified technician to examine it before continuing to use it.



Batteries contain lead and acid, which is very corrosive. Batteries must be handled and disposed of in accordance with proper procedures.



Not intended to be used as a seat in a motor vehicle



When driving, always make sure that the backrest is in its fully upright position.



Use lead acid maintenance-free sealed batteries only.



WARNING!!! Special care must be taken to prevent children from operating the **AFISCOOTER C**. Do not allow unsupervised children to play near the **AFISCOOTER C** scooter while the batteries are charging.



Always drive carefully. Adjust your speed according to road conditions.

When turning at high speed, the **AFISCOOTER C** can become unstable. Before making sharp turns, reduce speed to minimum, to prevent roll-over.



The **AFISCOOTER C** is able to go up slopes higher than the recommended safe slope. However, do not drive on slopes whose incline you do not know. Always drive very slowly and do not drive on the side of such slopes. Before starting to drive, make sure your emergency brake operates properly.

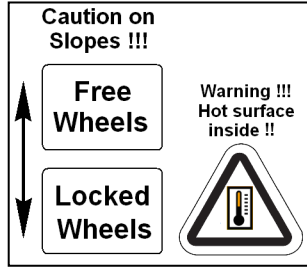

Do not release either the manual or the manual release lever of the electromagnetic brake (EMB) when the **AFISCOOTER C** is on a slope. When on any sort of an incline, never place the **AFISCOOTER C** in freewheel mode while seated on it or standing next to it.



The lights of **AFISCOOTER C** should be on when visibility is reduced, day or night.



Since your seat upholstery is fire resistant, do not cover it or replace with any upholstery other than upholstery of the same kind.

When removing the battery cover, watch out for hot parts. The motor, axle, EMB, electronic cards and electronic controller might be hot, Do not touch them until you have checked their temperature.



Make sure your fingers are not squeezed between the levers and the rubber grip.



Do not use a cell phone, walkie-talkie, laptop, or other radio transmitter while operating **AFISCOOTER C**.



Removal of the grounding prong can create electrical hazard. If it is necessary to use a 3-pronged electrical outlet, properly install an approved 2-pronged adapter.



Do not connect an extension cord to the AC/DC converter or to the battery charger.



Keep tools and other metal objects away from the battery terminals. Contact with tools can cause electrical shock. Do not sit on the **AFISCOOTER C** when it is on any type of lift/elevation product.



Explosive conditions exist



Disposal and recycling: The **AFISCOOTER C** consists of Recyclable materials (Plastic parts, batteries, electronics etc.). For information on proper disposal of your **AFISCOOTER C**, its parts and packaging, contact your authorized dealer.



Wear safety glasses.



Contains lead.



The battery charger is for indoor use only.



Flammable material. Do not expose to open flame.



At the rear of the **AFISCOOTER C** is the manual release lever of the EMB. When using this lever, be careful not to touch the surface of the motor, as it could be very hot and cause injury. See the warning label at the rear of the scooter near the lever.

CHAPTER 3 – SAFETY INSTRUCTIONS for *AFISCOOTER C*

GENERAL



MANDATORY! Do not operate your new *AFISCOOTER C* scooter for the first time without reading and understanding this user manual completely. Your *AFISCOOTER C* is a state-of-the-art life-enhancement device designed to increase mobility. We provide an extensive range of products to best fit the individual needs of the user. Please be aware that the final selection and purchasing decision regarding the type of *AFISCOOTER C* scooter to be used is the responsibility of a user who is capable of making such a decision and of his or her healthcare professional (i.e., medical doctor, physical therapist, etc.). The contents of this manual are based on the expectation that a mobility device expert has properly fitted *AFISCOOTER C* scooter to the user and has assisted the prescribing healthcare professional and/or the authorized dealer to give instructions for the use of the product.

There are certain situations, including some medical conditions, where the user will need to practice operating the *AFISCOOTER C* in the presence of a trained attendant. A trained attendant can be defined as a family member or a professional specially trained in assisting a user in various daily living activities.

As you begin using your *AFISCOOTER C* during daily activities, you will probably encounter situations in which you will need some practice. Simply take your time and you will soon be in full and confident control as you manoeuvre through doorways, on and off elevators, up and down ramps, and over moderately rough terrain.

Below are some precautions, tips, and other safety considerations that will help you operate the *AFISCOOTER C* safely.

MODIFICATIONS



We have designed and engineered your *AFISCOOTER C* to provide maximum mobility and utility. Under no circumstances should you modify, add, remove, or disable any feature, part, or function of your *AFISCOOTER C*.

WARNING! Do not modify your *AFISCOOTER C* in any way not authorized by the manufacturer. Do not use accessories if they have not been tested or approved by the manufacturer.

REMOVABLE PARTS



WARNING! Do not attempt to lift or move your *AFISCOOTER C* by any of its removable parts, including the armrests, seat, or shroud.

PINCHING POINTS



In the **AFISCOOTER C** there are some points that have potential to be pinching points. These refers mainly to moving parts such parts such as wheels throttle level etc. Never put your hands, fingers, or legs into any moving parts.

PRE-RIDE SAFETY CHECK



Get to know the feel of your **AFISCOOTER C** and its capabilities. We recommend that you perform a safety check before each use to make sure your **AFISCOOTER C** operates smoothly and safely.

Perform the following inspections prior to using your scooter:

- ✓ Check for proper tyre inflation. Maintain but do not exceed the psi/bar/kPa air pressure rating indicated on each tyre.
- ✓ Check all electrical connections. Make sure they are secure and not corroded.
- ✓ Check all harness connections. Make sure they are secured properly.
- ✓ Check the brakes.
- ✓ Check the battery charge.
- ✓ If you discover a problem, contact your authorized **AFISCOOTER C** dealer for assistance.

TYRE INFLATION



Your **AFISCOOTER C** is equipped with pneumatic tyres. Check the tyre pressure at least once a week. Proper inflation pressures will prolong the life of your tyres and help ensure the smooth operation of your **AFISCOOTER C**.

WARNING! It is critically important that the psi/bar/kPa air pressure indicated on each tyre is maintained at all times. Do not under-inflate or over-inflate your tyres. Under-inflation may result in loss of control, and over-inflation may burst the tyre. Failure to maintain the indicated pressure rating at all times may result in tyre and/or wheel failure.

WARNING! Inflate your scooter tyres from a regulated air source with an attached pressure gauge

NOTE: If the tyres on your **AFISCOOTER C** are marked with a psi rating only, use the following conversion formulas to find the bar or kPa rating:

$$\text{Bar} = \text{psi} \times 0.06895$$

$$\text{kPa} = \text{psi} \times 6.89476$$

WEIGHT LIMITATIONS



Your scooter is rated for a maximum weight capacity. Refer to Appendix A – Specification Sheet for details.

MANDATORY! Stay within the specified weight capacity for your **AFISCOOTER C**. Exceeding the weight capacity voids your warranty. We will not be held responsible for injuries and/or property damage resulting from failure to observe weight limitations.

WARNING! Do not carry passengers on your scooter. Carrying passengers on your **AFISCOOTER C** may result in instability.

INCLINE INFORMATION



More and more buildings have ramps with specified degrees of inclination, designed for easy and safe access. Some ramps may have turning switchbacks (180-degree turns) that require you to have good cornering skills on your **AFISCOOTER C**.

- ✓ Proceed with extreme caution as you approach the downgrade of a ramp or incline.
- ✓ Take wide turns with your **AFISCOOTER C** around any tight corners. If you do that, the scooter's rear wheels will follow a wide arc. Do not cut the corner short, and do not bump into or get hung up on any railing corners.
- ✓ When driving down a ramp, keep the **AFISCOOTER C** scooter's speed adjustment set to the slowest speed setting to ensure a safely controlled descent.
- ✓ Avoid sudden stops and starts.
- ✓ Refer to Figure A to determine the maximum slope, depending on scooter speed.
- ✓ **AFISCOOTER C** speed 12 km/hr: (450W)

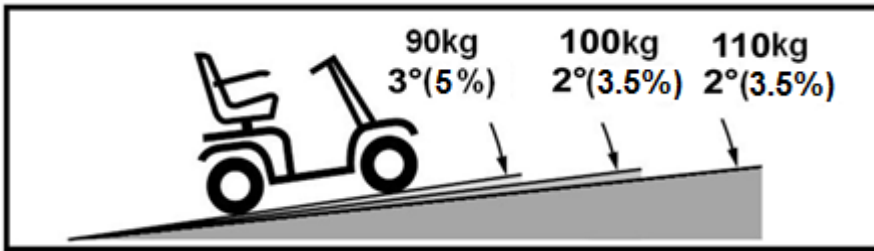

- ✓ **AFISCOOTER C** speed 10 km/hr: (450W)

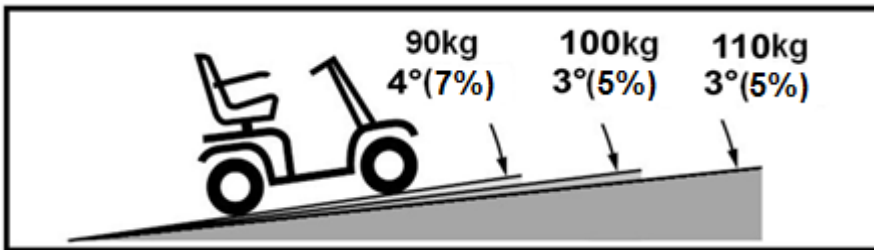

- ✓ **AFISCOOTER C** speed 15 km/hr: (950W)

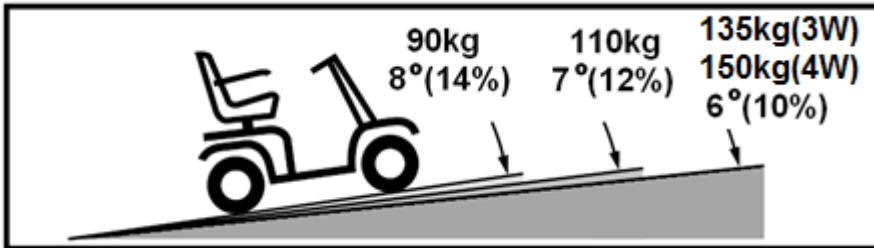

- ✓ **AFISCOOTER C** speed 12 km/hr: (950W)

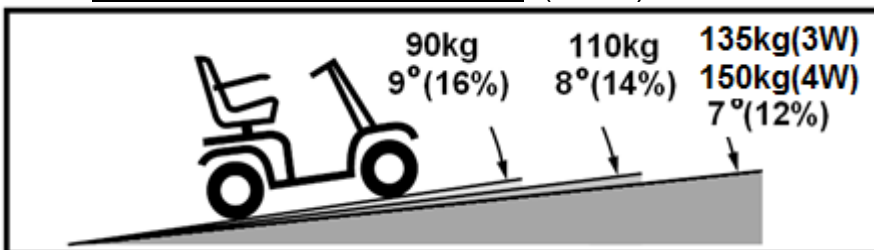

- ✓ **AFISCOOTER C** speed 10 km/hr: (950W)

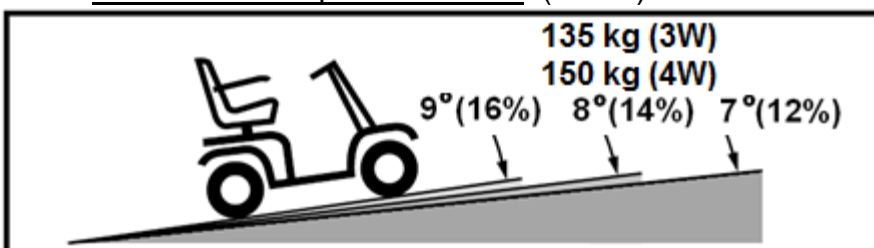

Figure A. Maximum Recommended Incline Angle

When driving up an incline, try to keep your **AFISCOOTER C** moving. If you must stop, start up again slowly, and then accelerate cautiously. When driving down an incline, set the speed switch to MIN and drive forward only. If your **AFISCOOTER C** starts to move down the incline faster than you want, allow it to come to a complete stop by releasing the throttle control lever, then push the throttle control lever forward slightly to ensure a safely controlled descent.

WARNING! When on any incline, never place the **AFISCOOTER C** in freewheel mode while seated on it or standing next to it.

WARNING! When climbing an incline, do not zigzag or drive up at an angle.

Always drive your **AFISCOOTER C** scooter straight up the incline. This greatly reduces the possibility of tipping over or a fall. Always exercise extreme caution when climbing an incline.

WARNING! Do not drive your **AFISCOOTER C** across an incline or diagonally up or down an incline; if possible, do not stop while driving up or down an incline.

WARNING! Do not drive up or down a potentially hazardous incline (e.g., areas covered with snow, ice, cut grass, or wet leaves).

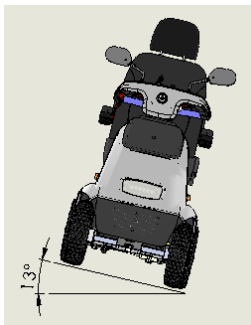

WARNING!

Even though your **AFISCOOTER C** is capable of climbing slopes greater than those illustrated in Figure A, do not, under any circumstances, exceed the incline guidelines or any other specifications presented in this manual. Doing so could cause your **AFISCOOTER C** to become unstable.

Note that public accesses ramps are not subject to government regulation in all countries, and therefore do not necessarily have the same standard degree of slope. Other inclines may be natural or not be designed specifically for scooters. Figure A illustrates your **AFISCOOTER C** stability and its ability to climb including under various weight loads and under controlled testing conditions.

These tests were conducted with the **AFISCOOTER C** seat in the highest position and in its farthest rearward position. Use this information as a guideline. Your **AFISCOOTER C** ability to travel up inclines is affected by your weight, scooter speed, your angle of approach to the incline, and your **AFISCOOTER C** setup.

WARNING! Any attempt to go up or down a slope steeper than shown in Figure-A may make your **AFISCOOTER C** unstable and cause it to tip.

WARNING! Never carry an oxygen tank weighing more than 15 lbs (6.8 kg). Never put more than 5 Kg (11 lbs) in the front basket or more than 8 Kg (17.6 lbs) in the rear basket.

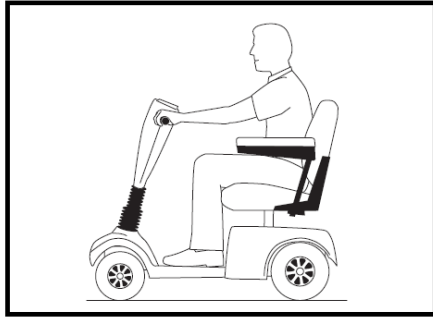

Figure B. Normal Driving Position

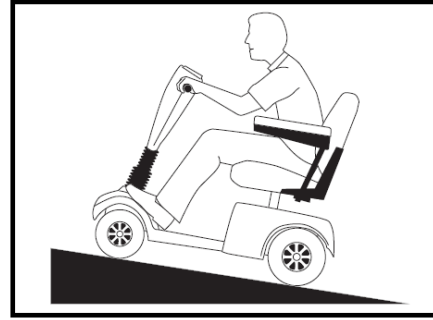

Figure C. Increased Stability Drive Position

When you approach an incline, it is best to lean forward. **See Figures B and C.** This shifts the centre of gravity of you and your **AFISCOOTER C** towards the front of the **AFISCOOTER C** for improved stability.

NOTE: *If the throttle control lever is released while you are moving forward up a ramp, the AFISCOOTER C may roll back approximately 1 foot (30 cm) before the brake engages. If the throttle control lever is released while you are moving in reverse, the AFISCOOTER C may roll back approximately 3 feet (one meter) before the brake engages.*

CORNERING INFORMATION

Excessively high cornering speeds can result in tipping. Factors that affect the possibility of tipping include, but are not limited to, cornering speed, steering angle (how sharply you are turning), uneven road surfaces, inclined road surfaces, riding from an area of low traction to an area of high traction (such as passing from a grassy area to a paved area – especially at high speed while turning), and abrupt changes of direction. High cornering speeds are not recommended. If you feel that you may tip over in a corner, reduce your speed and steering angle (i.e., lessen the sharpness of the turn) to prevent your **AFISCOOTER C** from tipping.

WARNING! When cornering sharply, reduce your speed and maintain a stable centre of gravity. When using your **AFISCOOTER C** at higher speeds, do not corner sharply. This greatly reduces the possibility of a tip or fall. Always exercise your common sense when cornering.

BRAKING INFORMATION

Your **AFISCOOTER C** is equipped with two powerful braking systems:

- ✓ Regenerative: Uses electricity to rapidly slow the vehicle when the throttle control lever returns to the centre/stop position.
- ✓ Park Brake: Activates automatically after regenerative braking slows the vehicle to a near stop, or when power is removed from the system for any reason.

OUTDOOR DRIVING SURFACES

- ✓ Your **AFISCOOTER C** is designed to provide optimum stability under normal driving conditions, on dry, level surfaces of concrete, tarmac, or asphalt. However, we recognize that there will be times when you will encounter other surfaces. For this reason, your **AFISCOOTER C** is designed to perform well on packed soil, grass, and gravel. Feel free to use your **AFISCOOTER C** safely on lawns and in parks.
- ✓ Reduce your **AFISCOOTER C** speed when driving on uneven terrain and/or soft surfaces.
- ✓ Avoid tall grass that can become tangled in the running gear.
- ✓ Avoid loosely packed gravel and sand.
- ✓ If you feel unsure about a driving surface, avoid it.

PUBLIC STREETS AND ROADWAYS

WARNING! Do not operate your **AFISCOOTER C** on public streets or roadways. It may be difficult for traffic to see you when you are seated on your **AFISCOOTER C**. Obey all local pedestrian traffic rules. Wait until your path is clear of traffic, and then proceed with extreme caution.

STATIONARY OBSTACLES (STEPS, CURBS, ETC.)



WARNING! Do not drive near raised surfaces, unprotected ledges, and/or drop-offs (curbs, porches, stairs, etc.).

WARNING! Do not try to go up or down an obstacle that is too high.

WARNING! Do not try to go backward down any step, curb, or other obstacle. This may cause the **AFISCOOTER C** to tip.

WARNING! Be sure your **AFISCOOTER C** is travelling perpendicular to any curb you may be required to go up or down.

WARNING! Do not attempt to climb a curb that is higher than 5 cm (2").

PRECAUTIONS DURING INCLEMENT WEATHER

Avoid exposing your **AFISCOOTER C** to inclement weather.

If you are suddenly caught up in rain, snow, severe cold or heat while operating your **AFISCOOTER C**, proceed to shelter at the earliest opportunity. Thoroughly dry your **AFISCOOTER C** before storing, charging, or operating it.

PROHIBITED! Operating in rain, snow, salt, mist/spray conditions, and on icy slippery surfaces can have an adverse affect on the electrical system.

WARNING! Prolonged exposure to extreme hot or cold weather may affect the temperature **AFISCOOTER C** parts, possibly resulting in skin irritation. Exercise caution when using your **AFISCOOTER C** in extremely hot or cold conditions or when exposing your **AFISCOOTER C** to direct sunlight for prolonged periods of time.



WARNING Surface temperatures can increase when exposed to external sources of heat (e.g. sunlight).

FREEWHEEL MODE



Your **AFISCOOTER C** is equipped with a manual freewheel lever that, when pushed forward, allows the **AFISCOOTER C** to be pushed. For more information about how to place your **AFISCOOTER C** in and out of freewheel mode, see Chapter 4 – General description of the **AFISCOOTER C**.

WARNING! When your **AFISCOOTER C** is in freewheel mode, the parking system is disengaged.

- ✓ Disengage the drive motors only on a level surface.
- ✓ Ensure the key is removed from the key switch.
- ✓ Stand beside the **AFISCOOTER C** to engage or disengage freewheel mode. Never do this while sitting on the **AFISCOOTER C**.
- ✓ After you have finished pushing your **AFISCOOTER C**, always return it to the drive mode to lock the brakes (pull the manual freewheel lever backward).
- ✓ An added feature built into the **AFISCOOTER C** is “push-too-fast” protection, which safeguards it against gaining excessive speed while in freewheel mode.

Push-too-fast operates in two different modes:

- ✓ If the key is in the OFF position while the **AFISCOOTER C** is in freewheel mode, the **AFISCOOTER C**'s controller activates regenerative braking when it is pushed faster than the pre-programmed maximum threshold. In this case, the controller is acting as a speed governor.
- ✓ If the key is in the ON position while the **AFISCOOTER C** is in freewheel mode, you will encounter considerable resistance at any speed. This prevents the **AFISCOOTER C** from gaining unwanted momentum should the freewheel lever be raised inadvertently while you are driving the **AFISCOOTER C**.
- ✓ When using this lever, be careful not to touch the internal surface of the motor, as it could be very hot and cause injury. See the warning label at the rear of the scooter near the lever.

STAIRS AND ESCALATORS

AFISCOOTER C scooters are not designed to travel up or down stairs or escalators. Always use an elevator.

WARNING! Do not use your **AFISCOOTER C** scooter to negotiate steps or escalators.

DOORS

- ✓ Determine whether the door opens toward or away from you.
- ✓ Use your hand to turn the knob or to push the handle or push-bar.
- ✓ If the door opens away from you, drive your **AFISCOOTER C** gently and slowly forward to push the door open.
If the door opens towards you, drive your **AFISCOOTER C** gently and slowly backwards to pull the door open.

ELEVATORS

Modern elevators have a safety mechanism on the edge of the door that, when pushed, reopens the door(s).

- ✓ If you are in the doorway of an elevator when the door(s) begin to close, push on the rubber door edge or allow the rubber door edge to contact the **AFISCOOTER C**; and the door will reopen.
- ✓ Take care that handbags, packages, or **AFISCOOTER C** accessories do not become caught in elevator doors.

NOTE: Sometimes manoeuvring your **AFISCOOTER C** may be difficult in elevators and building entrances. Use caution when attempting to manoeuvre your **AFISCOOTER C** in small spaces, and avoid areas that might pose a problem.

LIFTS/ELEVATION PRODUCTS

If you travel with your **AFISCOOTER C**, you may find it necessary to use a lift or elevation product to aid in transportation. We recommend that you closely review the manufacturer's instructions, specifications, and safety information before using the lift/elevation product.

WARNING! Never sit on your **AFISCOOTER C** when it is being used with any type of lift/elevation product. Your **AFISCOOTER C** was not designed for such use, and any damage or injury resulting from such use is your responsibility only.

BATTERIES (see also Replacing Batteries, page 28)



In addition to the following warnings below, be sure to comply with all other battery handling information.

MANDATORY! Battery posts, terminals, and related accessories contain lead and lead compounds. Wear goggles and gloves when handling batteries, and wash hands after handling.

WARNING! Scooter batteries are heavy. (See Appendix A – Specification Sheet). If you are unable to lift that much weight, be sure to get help. Use proper lifting techniques and avoid lifting beyond your capacity.

WARNING! Always protect the batteries from freezing and never charge a frozen battery.

WARNING! Connect the battery cables correctly. RED (+) cables must be connected to positive (+) battery terminals/posts and BLACK (-) cables must be connected to negative (-) battery terminals/posts. REPLACE damaged cables immediately. Protective caps must be installed over all battery terminals.

NOTE: *If the battery is damaged or cracked, immediately enclose it in a plastic bag and contact your local waste disposal agency or authorized **AFISCOOTER C** dealer for instructions for recycling.*

MOTOR VEHICLE TRANSPORTATION

The manufacturer recommends that you do not remain seated in your **AFISCOOTER C** while travelling in a motor vehicle. The **AFISCOOTER C** should be stowed in the boot of a car or in the back of a truck or van with the batteries removed and properly secured. In addition, all removable **AFISCOOTER C** parts, including the armrests, seat, and shroud, should be removed and/or properly secured during transportation.

WARNING! Although your **AFISCOOTER C** may be equipped with an optional tie-down belt, this belt is not designed to provide restraint during motor vehicle transportation. Anyone travelling in a motor vehicle must be properly secured in the motor vehicle seat with securely fastened seat belts.

WARNING! Do not sit on your **AFISCOOTER C** while it is in a moving vehicle.

WARNING! Always be sure your **AFISCOOTER C** and its batteries are properly secured when it is being transported. Batteries must be secured in an upright position, and protective caps must be installed on the battery terminals. Batteries must not be transported with any flammable or combustible items.

TIE-DOWN BELT

Although your **AFISCOOTER C** may be equipped with an optional tie-down belt, this belt is not designed to provide restraint during motor vehicle transportation. Anyone travelling in a motor vehicle must be properly secured in the motor vehicle seat with securely fastened seat belts.



WARNING! Do not sit on your **AFISCOOTER C** while it is in a moving vehicle.

WARNING! Ensure your **AFISCOOTER C** and its batteries are properly secured during transportation.

PREVENTING UNINTENDED TRAVEL

WARNING! If you anticipate being stationary for an extended period of time, turn off the power. This will prevent unexpected travel caused by accidentally touching the throttle control lever.

GETTING ONTO AND OFF YOUR **AFISCOOTER C**



Getting onto and off your **AFISCOOTER C** requires a good sense of balance. Please observe the following safety tips when getting on and off your **AFISCOOTER C**:

- ✓ Remove the key from the key switch.
- ✓ Ensure that your **AFISCOOTER C** is not in freewheel mode
- ✓ (see Chapter 4 - General description of the **AFISCOOTER C**).
- ✓ Ensure that the seat is secured in place.
- ✓ Pivot the armrests up

WARNING! Position yourself as far back as possible in the seat to prevent the **AFISCOOTER C** from tipping and causing injury.

WARNING! Avoid putting all of your weight on the **AFISCOOTER C** armrests, and do not make the armrests bear weight, such as during transfers. Such use may cause the **AFISCOOTER C** to tip, resulting in a fall from the **AFISCOOTER C** and/or personal injury.

WARNING! Avoid putting all of your weight on the floorboard. Such use may cause the **AFISCOOTER C** to tip.

REACHING AND BENDING

Avoid reaching or bending while driving your **AFISCOOTER C**. Bending forward creates the risk of accidentally contacting the throttle control lever. Bending to the side while seated creates the risk of tipping. It is important to maintain a stable centre of gravity to keep the **AFISCOOTER C** from tipping. We recommend that you determine your personal limitations and practice bending and reaching in the presence of a qualified attendant.

WARNING! Do not bend, lean, or reach for objects if you have to pick them up from the **AFISCOOTER C** deck or from either side of the **AFISCOOTER C** such as these may change your centre of gravity and the weight distribution of the **AFISCOOTER C**, causing it to tip.

PROHIBITED! Keep your hands away from the tyres and wheels when driving. Be aware that loose-fitting clothing can be caught in tyres and wheels.

PRESCRIPTION DRUGS/PHYSICAL LIMITATIONS

The **AFISCOOTER C** user must exercise care and common sense when operating the **AFISCOOTER C**. This includes awareness of safety issues when taking prescription/over-the-counter drugs or when the user has specific physical limitations.

WARNING! Consult with your physician if you are taking prescription or over-the-counter medication or if you have certain physical limitations. Some medications and limitations may impair your ability to operate your **AFISCOOTER C** in a safe manner.

ALCOHOL/SMOKING



The **AFISCOOTER C** user must exercise care and common sense when operating the **AFISCOOTER C**. This includes awareness of safety issues while under the influence of alcohol, or while smoking.

WARNING! Do not operate your **AFISCOOTER C** while you are under the influence of alcohol, as this may impair your ability to operate the **AFISCOOTER C** in a safe manner.

WARNING! The manufacturer strongly recommends that you do not smoke while seated on your **AFISCOOTER C**, although the **AFISCOOTER C** seat has passed the necessary testing requirements for resistance to ignition According to EN 1021-2:2006. You must adhere to the following safety guidelines if you decide to smoke cigarettes while seated on your **AFISCOOTER C**.

- ✓ Do not leave lit cigarettes unattended.
- ✓ Keep ashtrays a safe distance from the seat cushions.
- ✓ Always make sure cigarettes are completely extinguished before disposal.

ELECTROMAGNETIC AND RADIO FREQUENCY INTERFERENCE (EMI/RFI)



WARNING! Laboratory tests have shown that electromagnetic and radio frequency waves can have an adverse affect on the performance of electrically powered mobility vehicles.

EMI/RFI can come from sources such as cellular phones, mobile two-way radios (such as walkie-talkies), radio stations, TV stations, amateur radio (HAM) transmitters, wireless computer links, microwave signals, paging transmitters and medium-range mobile transceivers used by emergency vehicles. In some cases, they can cause unintended movement or damage to the control system. Every electrically powered mobility vehicle has an immunity (or resistance) to EMI.

The higher the immunity level, the greater the protection against EMI. This product has been tested and has passed at an immunity level of 20 V/M.

WARNING! Be aware that cell phones, two-way radios, laptops, and other types of radio transmitters may cause unintended movement of your electrically powered **AFISCOOTER C** due to EMI. Exercise caution when using any of these items while operating your **AFISCOOTER C** and avoid coming into close proximity of radio and TV stations.

WARNING! The addition of accessories or components to an electrically powered mobility vehicle can increase its susceptibility to EMI. Do not modify your **AFISCOOTER C** in any way not authorized by the manufacturer.

WARNING! The **AFISCOOTER C** itself can interfere with other electrical devices located nearby, such as alarm systems.

NOTE: For further information on EMI/RFI refer to chapter 10 or ask your authorized dealer.

CHAPTER 4 – GENERAL DESCRIPTION OF THE AFISCOOTER C

Note: The numbers in parentheses refer to the parts illustrated on Figures 1, 2, and 3.

Figure 1

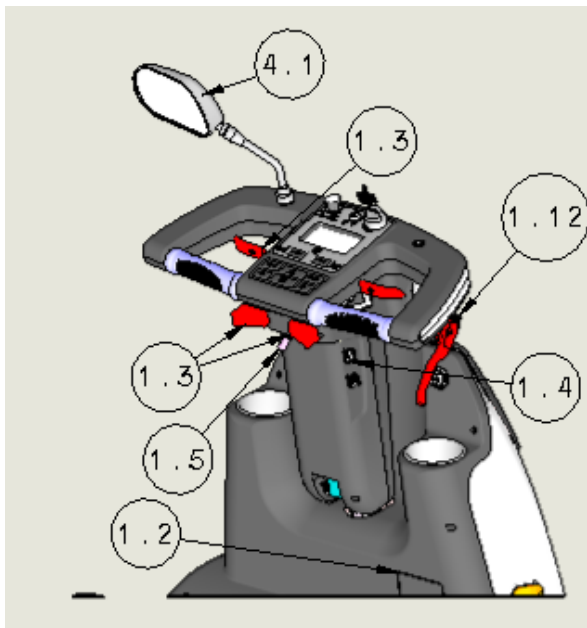

Figure 2

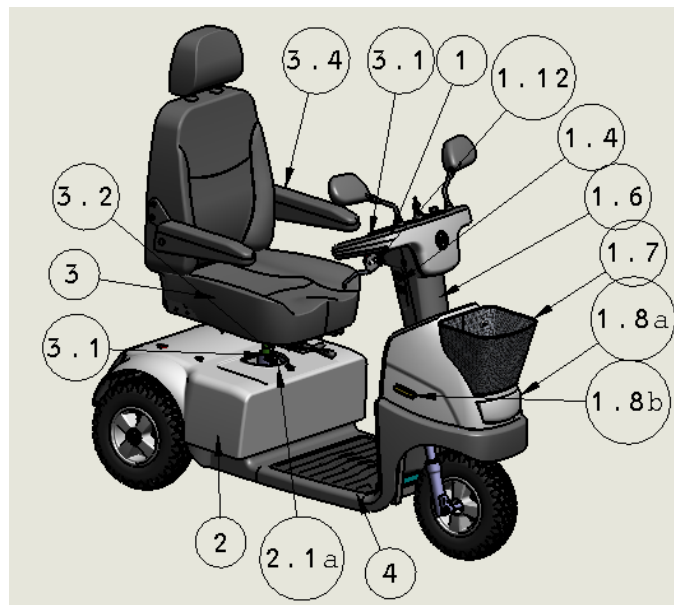
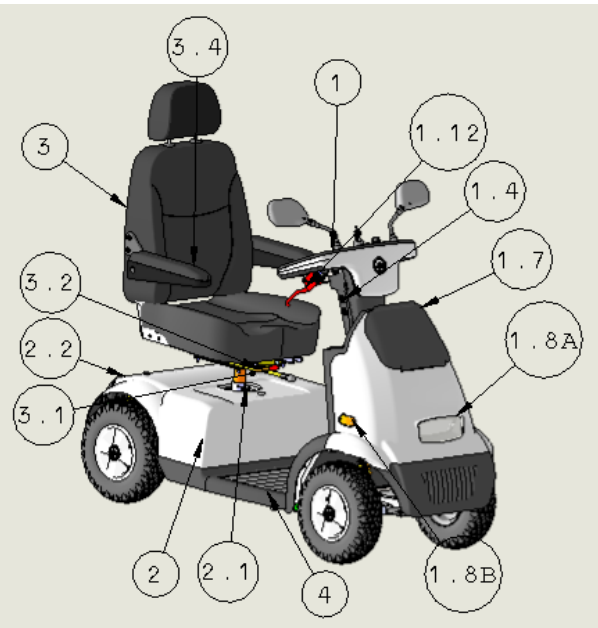



Figure 3

Plate with serial number and manufacturer's data (1.2)	Serial number and manufacturer's data are on a plate on the mud guard in front of your foot.
Tiller (1) / Handlebars (1)	Your AFISCOOTER C is designed for either hand operation, but it is delivered with right-hand controls. Left-hand controls can be set up by your dealer.
Mirror (4.1)	Every AFISCOOTER C has either 1 or 2 rear-view mirrors.
Throttle control lever (1.3)	Used to control the AFISCOOTER C speed.
Brake lever (1.12)	Used to brake in emergency conditions or when needed.
Charging socket (1.4)	Used to connect the charger plug to charge the battery.
Handlebar adjustment lever (1.5)	The handlebar can be adjusted forward or backward. Release the lever, make the adjustment, and return the lever to the locked position.
Front basket (1.7)	For carrying parcels and personal effects. Maximum load 5 kg (11 lbs).
Headlight (1.8) and front blinkers (1.8)	(A) Headlight for poor visibility conditions (B) Blinkers for turnings signals
USB Charger(1.20)	Use for charger mobile phone
Battery cover (2)	Protects the power unit, electronics and batteries.
Fuses (2.1a, 2.1b)	2.1a -- Main fuse 70A – Semi Automatic 2.1b -- Charge fuse 10A – Semi Automatic Located between the rear wheel and the battery cover.
EMB manual release (2.2)	A manual release lever at the back of AFISCOOTER C lets you push or pull it. Push / Pull the lever as shown on the label:  = Release (Push),  = Engaged (Drive). When the lever is in the released position AFISCOOTER C cannot be operated / driven. Note: After Lever is operated, you will need to Reset the system= key switch OFF and ON again. Note: Never release the lever when the AFISCOOTER C is on a slope.
Rear Bumper (2.2)	
Rear pilot & brake lights (2.2)	
Rear blinkers (2.2)	
Seat (3)	AFISCOOTER C seat is equipped with folding armrests (7.3) to allow convenient access to the seat. The seat itself can be rotated to allow easy access.
Armrests (3.4)	Use for comfortable entrance. May be folded upwards
Seat forward/reverse lever (3.1)	Used to move the seat forward and backward.
Seat rotation lever (3.2)	Used to swivel the seat 45° or 90° in either direction.
Floor (4)	Covered with carpet that may be removed for cleaning.

CHAPTER 5 – ADJUSTMENT INSTRUCTIONS

(Numbers refer to Figures 4 and 5)

Adjusting the tiller angle (1.5)	Adjust the angle of the tiller as follows: <ul style="list-style-type: none"> • Release the tiller adjustment lever (1.5), by pushing it down. • Release the lever at the desired place.
Adjusting the handlebar height	Handlebar height can be adjusted about 25mm by a technician.
Seating in the AFISCOOTER C	Before attempting to drive AFISCOOTER C , make sure the plug is disconnected from the charging socket (1.4). Note: While the plug is in the charging socket, AFISCOOTER C cannot be operated. Use the seat rotation lever (3.2) to rotate the seat sideways, and raise the armrest (3.4) to give you easy access to the seat. Use the seat forward/reverse lever (3.1) to adjust the location of the seat.
Handlebars and hand protectors	When driving always keep your hands on the handlebars (1) and within the hand protectors.
Adjusting the shock absorbers to the user	It is possible to adjust the rear shock absorber to the required load, or way of using AFISCOOTER C. If necessary, ask a technician to adjust the absorbers for your needs.

Figure 4

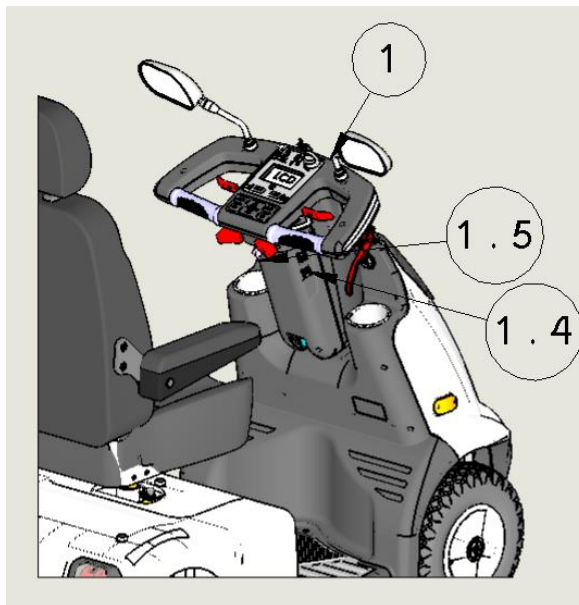
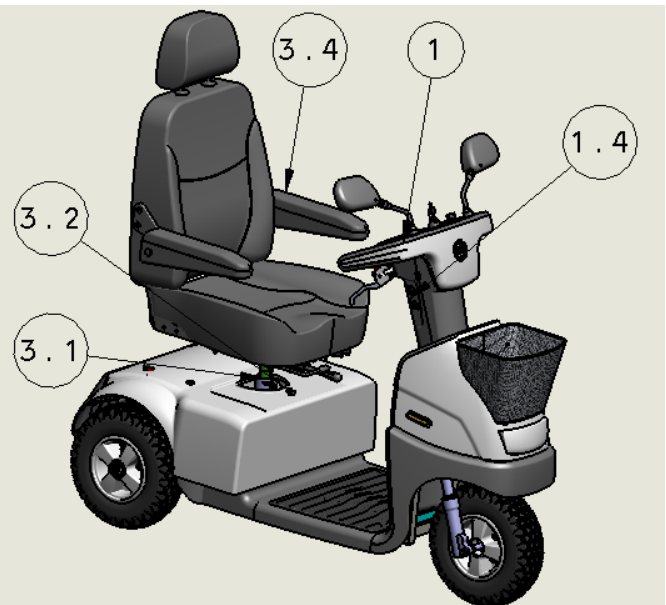

Figure 5



CHAPTER 6 – OPERATING INSTRUCTIONS

6.1 GENERAL

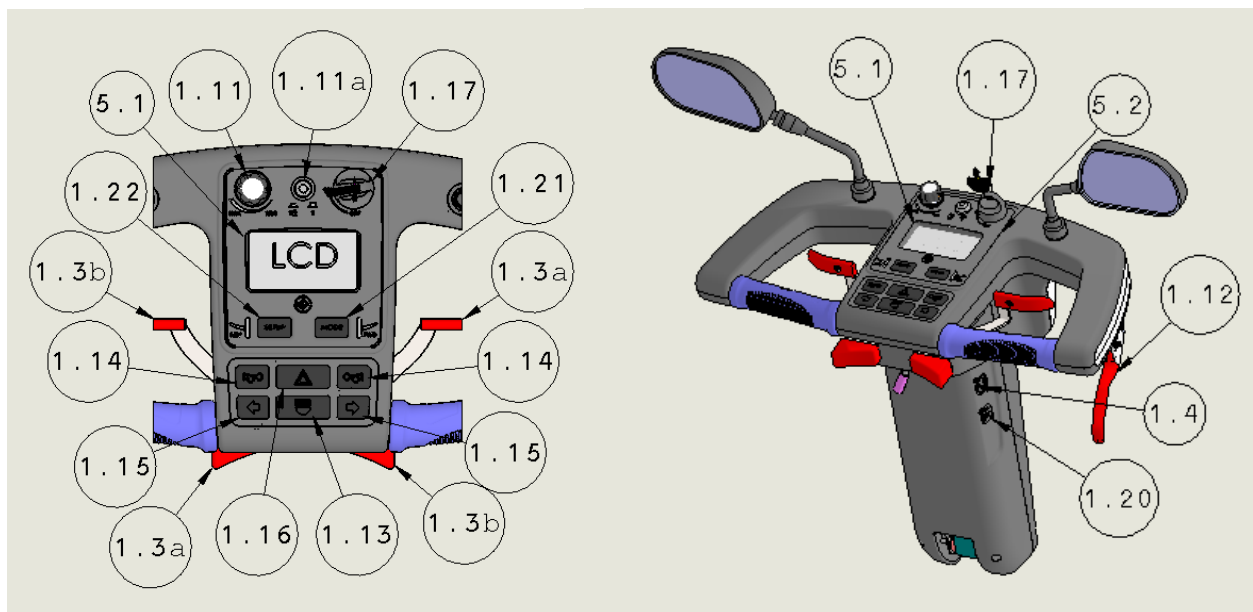

Figure 6

(Numbers refer to Figures 6 and 7)

Key switch (1.17)	<ul style="list-style-type: none"> The main key switch is located at the top of the tiller box (1). The key switch has two positions: <ul style="list-style-type: none"> ✓ OFF - The AFISCOOTER C cannot be driven and the EMB is locked. ✓ ON - Power is supplied to the AFISCOOTER C and the EMB is released automatically when the throttle control lever is squeezed. <p>To operate the AFISCOOTER C, insert the key in the key switch and turn it to ON (clockwise). The switch will remain in this position and the green LED (5.2) will be lit.</p> <p>Note: The key switch is used to operate AFISCOOTER C, not for locking.</p>
Automatic shut off	<p>When the key switch is in ON, the control system will be shut off automatically after a few minutes (usually 20) in order to save battery energy.</p> <p>In the case of automatic shut-off, turn the key switch OFF and then ON again.</p>
Adjusting the handbrake	<p>The handbrake cable mechanism can be adjusted by an authorized technician.</p> <p>The handbrake is part of your safety system. DO NOT adjust it yourself—get professional assistance!</p>
Throttle control lever and manual handbrake	<p>To drive: Gently squeeze the throttle control lever (1.3) until you reach the desired speed. Your speed is directly proportional to the deflection of the throttle control lever.</p> <p>To stop: Release the throttle control lever (1.3). The AFISCOOTER C will stop gradually, automatically.</p> <p>Note: You can also use the manual handbrake for emergency stopping (1.12).</p>
Signalling	<p>Before you turn, press the applicable turn signal switch: left or right (1.15) To turn off the indicator, press the switch forward.</p>

	When a turn indicator is activated, the applicable LED will flash. Depending on the model, a buzzer may also sound (subject to local regulations). To turn off the indicator, press the button again.
Buzzer buttons (1.14)	Push one of the 2 Buttons (1.14) to activate the buzzer. The buzzer sounds automatically under the following conditions (<i>except where prohibited by law</i>),: 1. When reversing 2. When operating the left or right indicator <u>Remark:</u> It is possible to change the Buzzer functionality by changing a dip switch in the front board .This needs to be done by an authorized technician.
Headlight switch (1.13)	To turn on the headlight and rear lights, press the Lights button (1.13). When the lights are ON the lights led (5.6) is lit. To turn off the lights, press the button again.
Hazard button (1.16)	The Hazard button activates all the flashing lights on AFISCOOTER C . To turn off the hazard lights, press the button again. When the hazard lights are activated, both LEDs (5.3 & 5.4) flash.
Inhibit while charging	When AFISCOOTER C is being charged, it is in inhibiting mode. In this mode it cannot be driven. When being charged a signal will be lit.
Safe driving / Half speed switch (1.11)	When driving on ramps, high curbs and on sharp turns, drive very slowly and carefully, consider changing the Half Speed Switch (1.11) to Half speed mode. Never try to go over an obstacle that is more than the maximum recommended slope angle, and obstacle height given in the specification sheet. Always drive carefully and adjust your speed to the road conditions. Before making sharp turns, reduce AFISCOOTER C speed, to Half Speed, to prevent side roll-over.
LCD (5.1)	When driving and operating the AFISCOOTER S, all the required information is displayed on the LCD screen
MODE and RESET button (1.21)	The MODE / RESET button will change the digital reading from Speed to Travel Distance or Time. The distance is shown in km, or miles and the time displayed in hours. (Note: Setting the speed unit can be done by a technician. When you push the MODE button to the modes: "travel time" and "travel distance" and keep pushing it for more than 7 seconds, the "travel time" and "travel distance" will reset to zero.
Setup button (1.22)	The Setup button is used to set the clock.
Parking	After stopping AFISCOOTER C , turn the key switch (1.17) to OFF and remove the key. The LED will turn OFF. Note: The EMB locks automatically when the throttle control lever is released and AFISCOOTER C has come to a complete stop.

6.2 LCD DISPLAY USE

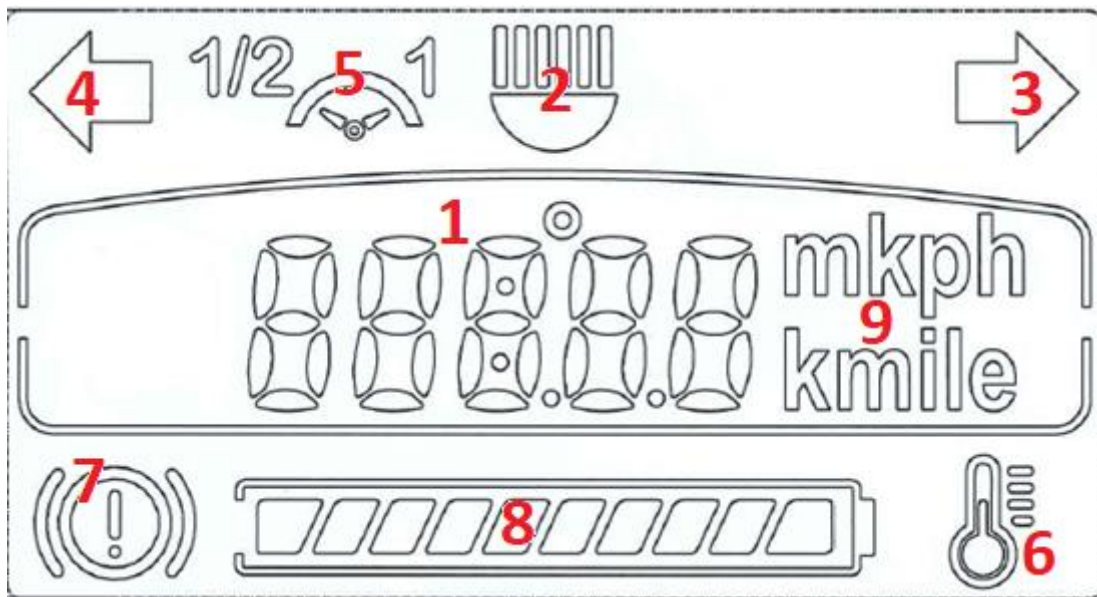

LCD Display Key	When driving and operating the AFISCOOTER S, all the required information is displayed on the LCD screen (5.1). See details below.
Battery status Indicator	The Battery Capacity Indicator (8) on the LCD screen, displays the remaining battery capacity. Like petrol gauges in cars, the indicator is not absolutely accurate; it is merely a guide to help you stop running out of fuel. The accuracy of the indicator also depends on the type and age of the batteries. When the indicator shows 2-3 bars, recharge batteries as soon as possible. When the indicator displays one blinking bar, recharge immediately. You can only drive a short distance (3-4 km on level surface). The accuracy of the battery indicator reading also depends on the type and age of the batteries.
Fault indicator	AFISCOOTER C is equipped with fault indication. The fault indication appears as a flashing code of the battery indicator, as well as an error code on the LCD screen (1.1). For further details see AFISCOOTER Maintenance Manual.
Light indicator	When the main lights are ON (front and rear) a sign will be lit (2).
Blinker indicators	When the blinkers are ON, signs will be lit 3 and / or 4.
Half speed indicator	When the Half Speed switch (1/2) is at the Half Speed position, a sign of "1/2" will be lit (5).
Alarm indicator	When one of the following conditions exists: Motor overheating, panic brake was operated or manual release brake is in the OPEN position, or electric EMB is opened, the alarm indicator will be lit (7).
Speed display (1)	The LCD screen digital area will display the speed of AFISCOOTER C . The speed is shown in kph or mph. The setting can be done by a technician.

Motor high temperature indicator (6)	Not relevant																					
Clock setup	<p>When changing to clock mode with the MODE button, press it for 7 seconds and you will enter the Setup mode of the clock.</p> <p>Adjusting the clock : Use the left Setup button and the right Mode button as follows: Every push on Mode changes the time unit and the selected unit flashes. During the flashing, every push on Setup increases 1 unit.</p> <table border="1"> <thead> <tr> <th>Stage</th> <th>Display</th> <th>Flashing</th> </tr> </thead> <tbody> <tr> <td>1</td> <td>HH:mm</td> <td>mm</td> </tr> <tr> <td>2</td> <td>HH:mm</td> <td>HH</td> </tr> <tr> <td>3</td> <td>DD.MM or MM.DD</td> <td>DD</td> </tr> <tr> <td>4</td> <td>DD.MM or MM.DD</td> <td>MM</td> </tr> <tr> <td>5</td> <td>20YY</td> <td>YY</td> </tr> <tr> <td>6</td> <td></td> <td>Saving the updated time and date</td> </tr> </tbody> </table>	Stage	Display	Flashing	1	HH:mm	mm	2	HH:mm	HH	3	DD.MM or MM.DD	DD	4	DD.MM or MM.DD	MM	5	20YY	YY	6		Saving the updated time and date
Stage	Display	Flashing																				
1	HH:mm	mm																				
2	HH:mm	HH																				
3	DD.MM or MM.DD	DD																				
4	DD.MM or MM.DD	MM																				
5	20YY	YY																				
6		Saving the updated time and date																				

6.3 DRIVING AND GENERAL USE

Climbing an	To climb an Obstacle, drive the AFISCOOTER C forward toward the
-------------	--

obstacle	obstacle until the front wheel touches the obstacle, then, maintaining your direction, increase speed.
Driving on slopes and turns	<p>Before making sharp turns, particularly on inclines, reduce speed to minimum,</p> <div data-bbox="751 271 935 521" style="text-align: center;">  </div> <p>to prevent side roll-over.</p> <p>AFISCOOTER C is able to go up slopes steeper than the recommended safe slope. Do not drive on inclines where you are not sure about the slope degree. However drive very slowly and avoid side angles higher than 18% (10°).</p>
Prior to use	After reading through this entire manual and before using AFISCOOTER C , do a visual check of all the parts of the vehicle, to make sure that there is no visible damage. If you have any questions or concerns, contact your dealer.
Controller programming	Several parameters of AFISCOOTER C controller can be programmed. Programming must be done by trained authorized technician only. Incorrect programming can cause abnormal operation of AFISCOOTER C and may result in damage and personal injury.
Performance check	<p>A performance check is highly recommended when you first receive your AFISCOOTER C or after a period of not using the AFISCOOTER CS, as follows:</p> <ol style="list-style-type: none"> 1. Turn on the key switch. 2. Verify that both the green ON LED and the battery status indicator are lit. 3. Slowly squeeze the drive control lever and verify that the AFISCOOTER C travels at a speed that corresponds to the degree to which you are squeezing the lever. 4. Release the throttle control lever and verify that the AFISCOOTER C stops smoothly, and that you hear the click of the EMB engaging. 5. Check that all the buttons on the handlebar work correctly. 6. Switch off the key switch. <p>Your AFISCOOTER C is now ready to drive.</p>
Prior to use	Before using the AFISCOOTER C, be sure you know your own weight and the weight of any items you will be carrying on it. The maximum total load is 135 kg (300 lbs) 3 WHEELS /150 kg (330 lbs) 4 WHEELS. (Depending on the model).
Safety\Seat belt	Use a seat belt whenever it is needed for as anterior pelvic support or as required by local traffic regulations. A seat belt can be ordered from local supplier (see options for AFISCOOTER C in Appendix A) .
Securing the AFISCOOTER C in motor vehicle for transportation	<p>To transport the AFISCOOTER C in a motor vehicle, it must be secured (see Figure 8).</p> <p>Using standard approved tiding straps, secure the 4 tiding ear plates painted in Yellow (2 at the front and 2 at the rear of the scooter), to the car secure hooks.</p> <p>Warning: When transporting the AFISCOOTER C, never let anyone sit on it.</p>

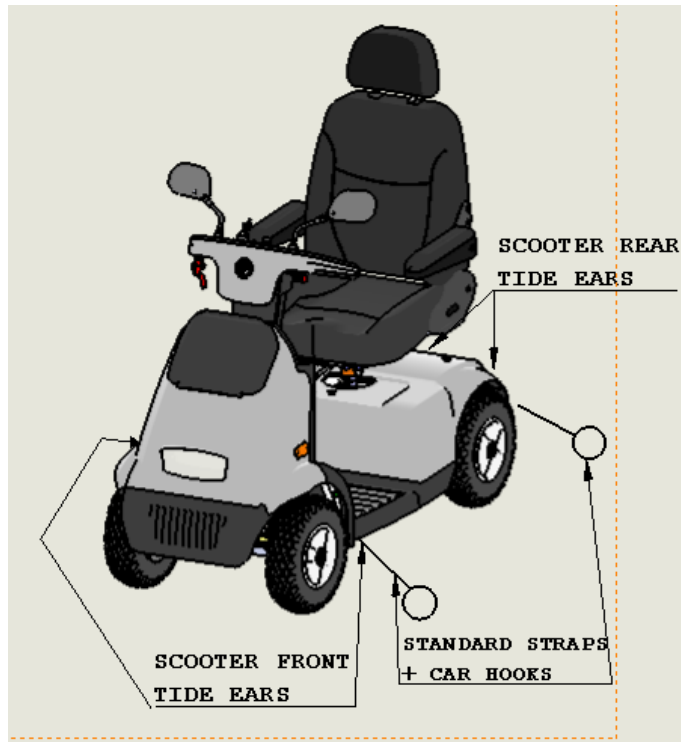

Figure 8

Transportation

To reduce the height of **AFISCOOTER C** while transporting it, the seat can be removed as explained in Chapter 8 Maintenance, and the handlebar column can be folded to horizontal position.

CHAPTER 7 – CHARGING

Read the charger manual before using it.

Warning: If you use a charger other than the one supplied with your *AFISCOOTER C*, ask your dealer for instructions.

CHARGING BATTERIES (See figure 9)

1. Insert the charger plug (8) in the charging socket (10) located on the right side of the tiller column.
2. Plug the charger power cord (9) into a wall socket (11).
3. When charging is complete, remove the charger power cord (9) from the wall socket (11) and then remove the charger plug (8) from the charging socket (10).
4. Under ideal storage conditions, batteries that were charged to full capacity and were not used should be recharged every 6 months.
 - . If you expect not to use your *AFISCOOTER C* for an extended period of time, we recommend charging it for two days and then disconnecting the batteries.
5. If you have not used your *AFISCOOTER C* for an extended period of time, charge the batteries for at least 24 hours before driving.

Recommended Charging routine

1. Use the scooter along the day as needed or until charging is low , according to the LCD battery indicator.
2. At the end of the day, recharge the scooter batteries along the night.
3. No need to disconnect the batteries at the end of the charging. The charger is Automatic and stops itself.
4. No need to recharge the scooter batteries at the end of every drive, unless you are not intending to use the scooter any more on that day.
5. In case of recharge the scooter along the day, you should perform full charging.
6. It is not recommended to leave the batteries uncharged for a few days as it can reduce the travel distance and battery's life.

- **As long as the charging plug is in the charging socket, the electronic control of the *AFISCOOTER C* automatically cuts all power to the electric system and it cannot be driven.**
- **The charger supplied is suitable for charging lead acid dry/gel batteries. Use only the defined type of charger. Before using any other type of charger, check with your dealer.**

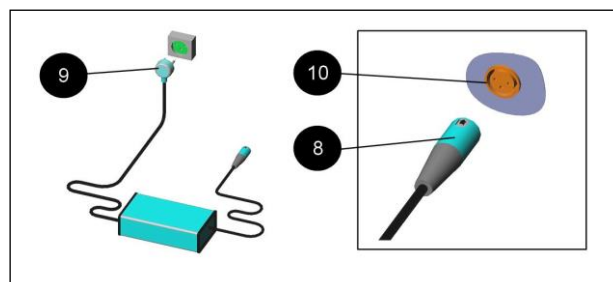

Figure 10

CHAPTER 8 – MAINTENANCE

Note:

1. Maintenance Manual is available for trained technicians.
2. The numbers in parentheses refer to the parts illustrated in figure 11.



Although the **AFISCOOTER C** requires very little maintenance, do not neglect it.

The expected service life is of the **AFISCOOTER C** is 7 years and it will extend much longer provided care and maintenance procedures are carefully followed.

When performing maintenance procedures on the **AFISCOOTER C**, make sure that it stands on a level surface and that the key is not inserted.

Periodic Maintenance Procedures

✓ **Remark:** For periodic maintenance, no special tools are needed.

No.	Type of Service	Frequency
1	Check air pressure in all tyres.	Every week
2	Check emergency brakes	Every week
3	Check normal driving and stopping	Every Month
4	Check tyre wear	Every Month
5	Check for missing and damaged parts (see Figures 1 through 4).	When first receiving AFISCOOTER C or after a long time without using it.
6	Check that all screws and parts are secure	Once a year by a technician.
7	Replace batteries (To replace the batteries, the seat and the battery cover (which is located under the seat) must be removed.)	<ul style="list-style-type: none"> • Every 2-3 years, • After about 300-400 full cycles of charge/discharge, • When the distance you can travel on a single charge becomes short, or • After a technician recommends replacing it.
  Used batteries should not be disposed of with the regular garbage. For information on proper disposal of your batteries contact your authorized dealer		
8	Cleaning	External – when needed. Internal – Once a year by technician.

Recommended periodic Performance checks

Slow or Sluggish Movement

If the scooter does not travel at full speed and the battery condition is good, check the position of the speed limiting control. If adjusting the speed limiting control does not remedy the problem then there may be a non-hazardous fault.

Contact your service agent.

User Daily Checks

Throttle: With the scooter switched off, check that the throttle mechanism is not bent or damaged and that it returns to the position when you push and release it. If there is a problem do not continue with the safety checks and contact your service agent.

User Weekly Checks

Throttle: Put the throttle to the full speed forward position and switch the scooter on. The scooter should not move. show you that you have switched the scooter on with the throttle already pushed.

If the scooter does move, contact your service agent.

Parking brake: This test should be carried out on a level surface with at least one meter clear space around the scooter.

Switch the scooter on.

Check that the status indicator remains on, or flashes slowly, after half a second.

Go to drive the scooter slowly in the forwards direction until you hear the parking brake operate. The scooter may start to move.

Immediately release the throttle. You must be able to hear the parking brake operate within a few seconds.

Repeat the test in the reverse direction.

Cables and connectors:

Check that all connectors on the scooter are securely mated, and ensure that all cables are free from damage.

As-required Detailed Maintenance Procedures

Type of Service	Frequency
Removing the seat and the Batteries Cover (2)	Turn the seat by turning the lever (7.5) 45° (either direction). The seat can be removed only at this angle. Removing the seat -(7) Holding the seat with one hand on the backrest, and the other at the front, lift it off the seat-mounting post.
	Warning! The seat weighs 20 kg (44 lbs). The seat must be lifted by two people or by an adequate lifting equipment. Replace the battery cover, re-install it over the seat-mounting post, and make sure it is seated properly, and then secure it with the five screws.
Removing and replacing the battery cover (2)	To replace the battery cover, re-install it over the seat-mounting post and make sure it is seated properly, then secure it with the four screws (2.6).
Batteries	Each battery weighs 23 kg (50.6 lbs). The batteries must be lifted by two people or by an adequate lifting equipment.
Tyres	Correct tyre pressure is essential for steering and stability. Check the tyre pressure every two weeks 25 ±2 psi. AFISCOOTER 4W front tires: 20±2 psi.
Cleaning	Use only a damp cloth and mild detergent for cleaning. Never use a hose, as this may severely damage the power and electronic components.

Type of Service	Frequency
Replace batteries	<p>Note! Batteries must be replaced by trained professionals only.</p> <p>Warning! Batteries contain high energy and can spark, resulting in a possible fire hazard.</p> <p>Warning! Working with batteries can cause damage and Injury if not done properly.</p> <p>In this procedure, refer to Figure 12.</p> <ol style="list-style-type: none"> 1. Remove the terminal insulating cap from one battery terminal. 2. Using a 10/13 mm key, unscrew the wiring from the terminal. Take care not to let the key touch any other terminal or metal part, as this could cause damage or injury. 3. Repeat steps 1 and 2 for all the other terminals. 4. Remove the old batteries and install the new ones. 5. Connect the wires of the new batteries as shown in Figure 11 (also shown on the label located near the batteries). 6. Screw down the terminals securely, and replace the insulating caps.

Battery wiring Label :(*)**

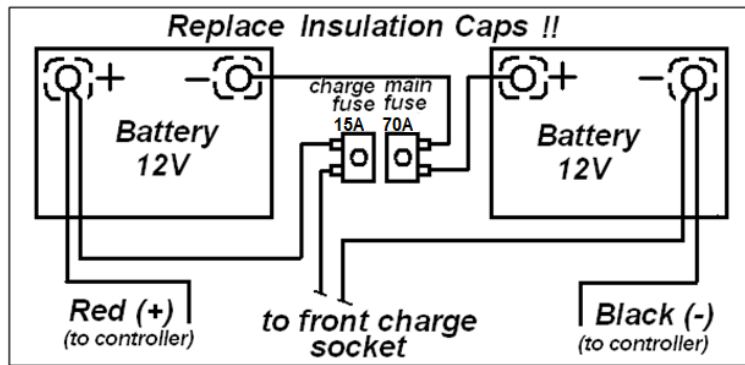

Rear Wiring connection and Fixing Instructions:

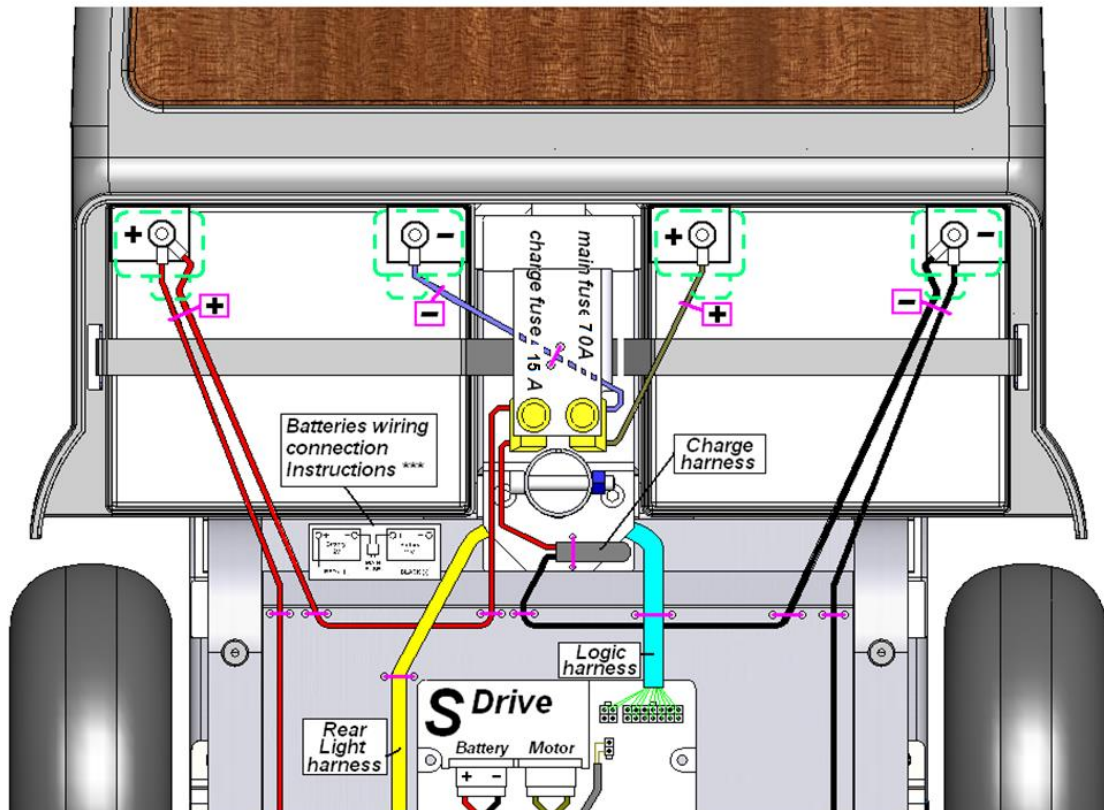

Figure 11

CHAPTER 9 – STORAGE

In Case of Long-term storage e.g. longer than four months, it is recommended to store the **Afiscooter C** in a dry, clean and secure space, ideally with a access to electricity socket so you can charge it.

During storage it is recommended that the **Afiscooter C** is covered and a closed Always. When the scooter is not in regular use, recharge the battery at least once a month until normal use is resumed. If you have left the power switch on or your product has not been charged for a long period of time,

We do not recommend storing your **Afiscooter C** in extremely cold conditions. Storing in temperatures below 10° Celsius diminishes runtime and battery capacity.

WARNING: DO NOT ALLOW TO FREEZE, DO NOT STORE BELOW 0°C' this could permanently damage your battery

CHAPTER 10 – TROUBLESHOOTING AND REPAIR



The following table provides troubleshooting and repair instructions for problems that may be encountered when operating the **AFISCOOTER C**, as well as the best way to correct the problem. The table contains three columns:

Symptom	Probable Cause	Remedy
The problem you are experiencing	The most likely causes, in order of probability (most likely first)	Recommended action to correct each probable cause

Remember: you can contact your dealer at any time for further professional support.

No.	Symptom	Probable Causes	Remedy
1	Flat tyre and unstable driving.	<ul style="list-style-type: none"> ✓ Low air pressure ✓ Puncture 	<ul style="list-style-type: none"> ✓ Pump tyre to normal pressure (see 'As-required Detailed Maintenance Procedures') ✓ Repair tyre
2	The LEDs flash and the vehicle does not move.	<ul style="list-style-type: none"> ✓ (identified by the fault code) 	<ul style="list-style-type: none"> ✓ Call for technical support
4	Handbrake is fully engaged but the vehicle does not stop.	<ul style="list-style-type: none"> ✓ Loose handbrake mechanism 	<ul style="list-style-type: none"> ✓ Brake cable needs to be tight. Only by authorized technician.
5	When throttle control lever is released on a level surface, the AFISCOOTER C takes longer than 3 meters to stop.	<ul style="list-style-type: none"> ✓ Controller is faulty or out of adjustment 	<ul style="list-style-type: none"> ✓ Call for technical support
6	Key switch is turned ON but the ON light does not come on.	<ul style="list-style-type: none"> ✓ Main fuse 50A popped or electrical fault. (See 2.1– in Fig. 1) 	<ul style="list-style-type: none"> ✓ Reset fuse <p>Note: Do not reset fuse more than twice. If the symptom still recurs, call your authorized dealer for support.</p>
7	AFISCOOTER C does not move when you squeeze the throttle control lever.	<ul style="list-style-type: none"> ✓ Key switch is OFF ✓ Charger is connected to charging socket ✓ The release lever of the EMB is disengaged. ✓ Other inhibitor: Panic brake. ✓ Control system failure 	<ul style="list-style-type: none"> ✓ Turn key switch ON ✓ Disconnect charger ✓ Engage the EMB lever. ✓ Turn the key switch OFF and ON again. ✓ Call for technical support
8	Intermittent drive.	<ul style="list-style-type: none"> ✓ Battery capacity is low ✓ Faulty connections ✓ Faulty battery 	<ul style="list-style-type: none"> ✓ Charge batteries for at least 18 hours ✓ Remove battery cover and check battery connection. If terminals are corroded, clean them with a damp, clean cloth ✓ If red LEDs are still on, contact your dealer for a replacement battery
9	Main or rear lights or indicator lights are inoperative.	<ul style="list-style-type: none"> ✓ Faulty LED light board or electronics fault 	<ul style="list-style-type: none"> ✓ Call technician for assistance.
10	When driving uphill or carrying heavy loads, speed reduces gradually (but scooter still moves).	<ul style="list-style-type: none"> ✓ The Controller became overheated 	<ul style="list-style-type: none"> ✓ Stop driving and let controller cool

Controller Fault codes shown on the display:

The display can show the controllers fault code in two different ways, set by parameter 8 in the display settings:

1. Error code displayed on alphanumeric display:

ERR01 – bad connection to the battery.

ERR02 – Bad connection to the motor.

ERR03 – The motor has a short circuit to a battery connection.

ERR04 – The Freewheel is activated while driving.

ERR06 – Electro-magnetic brake is manually open or panic button was pressed.

ERR07 – A Throttle fault is detected.

ERR08 – Controller error – make sure all connectors are fastened.

ERR09 – Bad connection between controller and electro-magnetic brake.

ERR10 – An excessive voltage has been applied to the controller. Check the battery connections.

2. Error code shown as a series of flashing signals on the error indicator:

1 Flashes	The battery needs charging or there is a bad connection to the battery. Check the connections to the battery. If the connections are good, try charging the battery.
2 Flashes	There is a bad connection to the motor. Check all connections between the motor and the controller.
3 Flashes	The motor has a short circuit to a battery connection. Contact your service agent.
4 Flashes	The freewheel switch is activated or the manual brake disengagement mechanism is operated. Check the position of the switch or lever.
5 Flashes	Not used.
6 Flashes	'The S-drive is being inhibited from driving. Inhibit 2 is active'. This may be because the battery charger is connected or the seat is not in the driving position.
7 Flashes	A throttle fault is indicated. Make sure that the throttle is in the rest position before switching on the scooter.
8 Flashes	A controller fault is indicated. Make sure that all connections are secure.
9 Flashes	The parking brakes have a bad connection. Check the parking brake and motor connections. Make sure the controller connections are secure.
10 Flashes	An excessive voltage has been applied to the controller. This is usually caused by a poor battery connection. Check the battery connections.

CHAPTER 11 – EMI WARNING



All types of electrically powered vehicles, such as powered wheelchairs and motorized scooters (in this text all types will be referred to as “powered vehicles”) may be susceptible to electromagnetic interference (EMI). This is from sources such as radio and TV stations, amateur radio (HAM) transmitters, two-way radios and cellular phones. The interference (from radio wave sources) can cause the powered vehicle to release its brakes, move by itself, or move in unintended direction. It can also damage the powered vehicle’s control system. The intensity of the interfering EM energy can be measured in volts per meter (V/m). Each powered vehicle can resist EMI interfering electromagnetic energy (EM) emitted up to a certain intensity. This is called its “immunity level”. The higher the immunity level, the greater the protection. At this time, current technology is capable of achieving an immunity level that would provide useful protection from the more common sources of radiated EMI. This vehicle as shipped, with no further modification, has an immunity level of 20 V/m.

There are a number of sources of relatively intense electromagnetic fields in the everyday environment. Some of these sources are obvious and easy to avoid. Others are not apparent and exposure is unavoidable. However, we believe that by following the warning listed below, your risk of EMI will be minimized.

The sources of radiated EMI can be broadly classified into three types:

1. Hand-held portable transceivers (transmitters-receivers) with the antenna mounted directly on the transmitting unit. Examples include: citizen band (CB) radios, “walkie talkies”, security, fire and police transceivers, cellular telephones and other personal communication devices.

NOTE: Some cellular telephones and similar devices transmit signals while they are ON, even when not being used.

2. Medium-range mobile transceivers such as those used in police cars, fire trucks, ambulances and taxis. These usually have the antenna mounted on the outside of the vehicle.

3. Long-range transmitters and transceivers such as commercial broadcast transmitters (radio and TV broadcast antenna towers) and amateur (HAM) radios.

NOTE: Other types of hand held devices, such as cordless phones, laptop computers, AM/FM radios, TV sets, CD players, cassette players and small appliances such as electric shavers and hair dryers, as far as we know, are not likely to cause EMI problems to your powered vehicle.

Powered Vehicle Electromagnetic Interference (EMI)



Because EM energy rapidly becomes more intense as one moves closer to the transmitting antenna, the EM field from hand-held radio wave sources (transceivers) are of special concern. It is possible to unintentionally bring high levels of EM energy close to the powered vehicle’s control system while using these devices. This can affect powered vehicle movement and braking.

Therefore, the warnings listed below are recommended to prevent possible interference with the control system of the powered vehicle.

WARNINGS

Electromagnetic interference (EMI) from sources such as radio and TV stations, amateur radio (HAM) transmitters, two-way radios and cellular phones can affect powered vehicles.

Following the warnings listed below should reduce the chance of unintended brake release or powered vehicle movement **which could result in serious injury:**

- 1) Do not operate hand-held transceivers (transmitters-receivers) such as citizen band (CB) radios, or turn ON personal communication devices such as cellular phones, while the powered vehicle is ON;
- 2) Be aware of nearby transmitters, such as radio or TV stations and try to avoid coming close to them.
- 3) On appearance of unintended movements or brake release occurrences, switch the powered vehicle OFF **as it is safe to do so.**
- 4) Be aware that adding accessories or components, or modifying the powered vehicle, may make it more susceptible to EMI (since there is no easy way to evaluate their effect on the overall immunity level of the powered vehicle).
- 5) Please report to us all incidents of unintended movement or brake release and note whether there is a source of EMI nearby.

Important information

- 1) 20 volts per meter (V/m) is a generally achievable and useful immunity level against EMI (as of May 1994). The higher the level the greater the protection;
- 2) This product delivered to you has an immunity level of 20 V/m.

Appendix A – Specification Sheet

Type: AFISCOOTER C3/C4

Manufacturer: Kibbutz Afikim 15148, Israel

Maximum occupant mass: 150 kg (for the tests, a 100kg (220 lbs) dummy according ISO 7176-11 was used, supplemented by 50kg(110lbs) weights distributed approximately proportional to the dummy's weight distrib.)

(Metric table)

Disclosure information (ISO 7176-15)					
Standard reference	min.	max.	Standard reference	min.	max.
Overall length with-4w leg rest - 3w	1366mm 1300mm		Seat plane angle		°3
Overall width	665 m		Effective seat depth	450 mm	
Folded length			Effective seat width	460 mm	
Folded height	805mm		Seat surface height at front edge	660 mm	
Total mass - 4w -3w	122 kg 102kg		Backrest angle		
Mass of the heaviest part			Backrest height	520 mm	
Static stability downhill			Foot rest to seat distance	255 mm	
Static stability uphill	13°		Leg to seat surface angle	93°	
Static stability sideways	10°	14°	Armrest to seat distance	160 mm	
Energy consumption			Front location of armrest structure	280 mm	
Dynamic stability uphill			Handlebar diameter	65mm	
Obstacle climbing	25 mm	100mm	Horizontal location of axle		
Maximum speed forward		15km/h 12km/h 10km/h	Minimum turning radius 4W – 3W --	340 cm 255 cm	
Minimum braking distance from max speed	2500 mm (on the flat)		Minimum turn-around radius		
Pneumatic Tires – All tires	4.10/3.50-6"		Charger for charging dry/gel acid battery	24VDC maximum charge 8 Amp.	
Pressure of front tires: Pressure of rear tires:		25 psi 25 psi			
Battery type ,Capacity Battery Dimensions Charger	Sealed Lead Acid /Gel/AGM, 2x12V 40-70Ah max. Dims. L=197mm x W=168mm x H=175mm Charge current 8 Amp. maximum				
Options	Left-hand drive tiller,		Rear basket		

(Inches table)

Disclosure information (ISO 7176-15)					
Standard reference	min.	max.	Standard reference	min.	max.
Overall length with - 4w leg rest - 3w	53.7" 51.2"		Seat plane angle		°3
Overall width	26.2"		Effective seat depth	17.7"	
Folded length			Effective seat width	18.1"	
Folded height	31.7"		Seat surface height at front edge	26"	
Total mass - 4w - 3w	268 lb 224 lb		Backrest angle		
Mass of the heaviest part			Backrest height	20.5"	
Static stability downhill			Foot rest to seat distance	10"	
Static stability uphill	13°		Leg to seat surface angle	93°	
Static stability sideways	10°	14°	Armrest to seat distance	6.3"	
Energy consumption			Front location of armrest structure	11"	
Dynamic stability uphill			Handlebar diameter	2.5"	
Obstacle climbing	1"	39.4"	Horizontal location of axle		
Maximum speed forward		10 mph 8 mph 6.7mph	Minimum turning radius 4W – 3W --	134" 100.4"	
Minimum braking distance from max speed	98.4" (on the flat)		Minimum turn-around radius		
Pneumatic Tires – All tires	4.10/3.50-6"		Charger for charging dry/gel acid battery	24VDC maximum charge 8Amp.	
Pressure of front tires: Pressure of rear tires:		25 psi 25 psi			
Battery type ,Capacity Battery Dimensions Charger	Sealed Lead Acid /Gel/AGM, 2x12V 40-70Ah max. Dims. L=7.7" x W=6.6" x H=6.9" Charge current 8 Amp. maximum				
Options	Left-hand drive tiller,		Rear basket		

Remarks:

- * All technical specifications are subject to change without prior notice.
- ** The maximum speed in every country is limited according local traffic regulations.
- *** Braking distance on slopes can be significantly greater than on level ground.

Date: July 2019

Edition: 02; Revision 01

Products: ***AFISCOOTER C, 4-Wheel and 3-Wheel***

P/N of the user manual: PRC4301