

# PRIDE®

MOBILITY  
LIVE YOUR BEST®

[www.pridemobility.com](http://www.pridemobility.com)

**Jazzy**  
carbon



OWNER'S MANUAL

**PRIDE®**  
MOBILITY  
LIVE YOUR BEST®  
[www.pridemobility.com](http://www.pridemobility.com)



401 York Ave  
Duryea PA, 18642

CONTENTS -----1

1. INTRODUCTION -----2

2. PRECAUTIONS FOR SAFE USE -----3-10

3. PERFORMANCE AND STRUCTURE -----11-12

4. ASSEMBLY/FOLDING/ADJUSTING -----13-16

5. USE AND OPERATION -----17-20







6. GENERAL GUIDANCE -----21

7. FAULT ANALYSIS AND TROUBLESHOOTING -----21

8. TRANSPORTATION AND STORAGE -----21

9. OPENING AND CHECKING -----22

10. QUALITY ASSURANCE -----23

	<p>Read and follow the information in the owner's manual.</p>
	<p>Locked and in drive mode. Place unit on level ground and stand to one side when changing from drive mode to freewheel mode or freewheel mode to drive mode. Unlocked and in freewheel mode.</p>
	<p>Class II Equipment</p>
	<p>Power Chair information label</p>
	<p>Manufactured in</p>
	<p>Do not remove the anti-tip wheels.</p>

Read and follow all instructions, warnings, and notes in this manual before attempting to operate your power wheelchair for the first time. If there is any information in this manual which you do not understand, or if you require additional assistance for assembly or operation, please contact your authorized local dealer.

To use your product safely depends on whether you strictly follow the warnings, attentions and operating instructions in this manual. The company shall not be responsible for any injury or damage caused by non-compliance with the warnings, attentions and operating instructions. These symbols below in this manual are used to identify warnings and important information. All of them are very important to your safety. It is strongly recommended that you should read and understand them completely.



**Warning! Failure to heed the warnings in the manual may result in personal injury.**



**Attention! Failure to heed the attentions in the manual may result in damage to the wheelchair.**

## 1. INTRODUCTION

1.1 This product integrates advanced technology with modern style. Especially, its structure for quick dis-assembly and assembly are very convenient for you to store or place at the trunk of your vehicle while traveling. We are certain that the design features, excellent performance and trouble free operation of this product will ensure more convenience in your daily life.

1.2 This power wheelchair is suitable for the disabled. The maximum loading weight is 136kg(300lbs).

1.3 This power wheelchair is of outdoor type, suitable for the use indoor and flat path near buildings, but not on grass, gravel roads, large slopes or motorway, and also not in rain or snow.

We reserve the right to change and update this manual without prior notice.

This power wheelchairs conformity to ISO7176 standards.

The manual will help you understand the function of the wheelchair. In addition, it also describes the operation, maintenance and repair. Any other questions, please contact your dealer or retailer.

## 2. Precautions for Safe Use



**Warning!** To ensure your safety, please read and understand this manual. You must be on high alert when driving any vehicle to ensure safety.



**Warning!** Please read the following warning carefully to avoid damage or personal injury caused by improper operation. Wheelchair users should take appropriate safety measures and obey local pedestrian traffic rules. The company are not responsible for personal injury and/or product damage caused by improper operation. When you sit in the wheelchair, it may be difficult for others to see you. Use of safety equipment such as reflectors, reflective clothing, lights and safety signs is critical to your safety.



**Warning!** Please consult your health care professional regularly to ensure that there are no health or physical conditions that limit or compromise your safe operation of the wheelchair. If you are taking prescription or over-the-counter medications, or if physical activity is limited, please consult your physician. Some medications and medical conditions may impair your ability to operate the wheelchair.



**Warning!** Do not operate your wheelchair while drunk. Drinking may affect your safe operation of the wheelchair.  
**Warning!** All wheelchairs are not the same. Please take time to learn before driving.  
**Warning!** Be able to operate a wheelchair safely needs time and practice.



**Warning!** Please do not use the wheelchair for other purposes, applications such as weight training, sports and athletics, traction, moving or dragging may cause safety hazards and excessive stress in wheelchairs.  
**Warning!** This wheelchair is for one person only, the maximum load weight as 135kg with no passengers allowed. Do not carry anything to avoid overloading and possible rollover.



Warning! We strongly recommend that you do not smoke in the wheelchair. If you decide to smoke in the wheelchair, please abide by the following safety rules: keep ash at a safe distance from the wheelchair seat. Make sure your cigarette is extinguished completely when you throw it away.



Warning! Before getting on/off the wheelchair, you should sit back as far as possible to avoid injury caused by overturning.  
Warning! The arm rests are not transfer bars, do not use them transfer out of the chair as this may cause damage to the product or injury to yourself.  
Warning! Avoid concentrating your weight on the footrest. Otherwise, it will cause overturning and personal injury.



Warning! Do not use the wheelchair in manual mode without accompanying person, which could cause personal injury.  
Warning! When sitting in the wheelchair, please do not move by yourself, which will cause personal injury. Ask your accompanying person for help if necessary.  
Warning! Do not make any alterations to the wheelchair without permission. Adding accessories may change some of the wheelchair specifications such as total weight, size, or center of gravity. Please note that some changes may damage things around you.  
Warning! Please do not change your seat specification. Do not place any cushions or pillows on the seat, which could result in the user falling out from the wheelchair caused by instability of seat.



Warning! Be extremely careful when using oxygen near electrical circuits or combustible materials. Please contact your oxygen supplier for information on the safe use of oxygen.



Attention! Do not change the controller Settings. Please ask your service provider to check the controller Settings every 6-12 months. If you notice any changes in your ability to control the wheelchair, please contact your service provider.



Warning! During the operation, the wheelchair may suddenly stop at any time. Do not operate the wheelchair if it is abnormal or irregular.



Warning! To prevent the wheelchair from losing control and moving on its own, do not place the wheelchair in manual mode on any inclined plane.



Warning! If you expect to sit in a fixed position for a long time, turn off the power to prevent accidental movement of the wheelchair.



Warning! Avoid any accessories that may interfere with the operation of the joystick. Otherwise, it will cause the wheelchair to move unexpectedly.



Warning! Keep yourself, clothing and other objects away from the wheel while the wheelchair is moving. Do not drag anything behind the wheelchair while driving. Loose clothing and other items can get sucked into tires and/or turning gears.



Attention! Do not connect any other devices to the electronic system or turn on any other devices with the wheelchair battery.  
Attention! When disconnecting wiring harness, please hold the terminal in case damage to it. Do not pull the wiring harness directly.



Warning! Keep all charger connector terminals clean and dry, away from damp sources to prevent damage to electrical system and/or personal injury.



Attention! The storage temperature of wheelchair is -15°C~40°C. Long-term storage in low or high temperature environment will damage its function.



Attention! Always check electrical components for corrosion. Check all brakes for looseness, wear or damage. Check wiring harnesses and terminal posts for breakage. If necessary, please contact your service provider.



Attention! Please ensure the safety of wheelchairs and batteries during transportation. Never transport wheelchairs or batteries with combustible materials.



Attention! Please use the battery under the supervision of service technicians authorized by the company. Battery connectors, terminals and related accessories contains lead and lead components to contains lithium, lead and lead components



Attention! Do not connect the cable directly to the battery terminal/clip for charging.  
Attention! Do not remove the fuse from the battery harness. If the fuse is damaged, please contact your supplier for replacement.



Warning! Do not operate the wheelchair with dead battery. You might get trapped.  
WARNING! Please slow down when turning, do not make sharp turns. Keep the center of gravity stable when turning. To prevent rollover, do not move the center of gravity in the opposite direction when turning.



WARNING! Drive straight up the slope when climbing; both front wheels should land at the same time. To reduce the possibility of overturning, do not make an angle with the slope; do not make the wheel on one side or the side of the wheelchair to go up the slope first. Be particularly careful when climbing any slopes.



WARNING! Do not drive on potentially dangerous roads or slopes, including but not limited to roads covered with snow, ice, cut grass, or wet leaves.



WARNING! Keep the wheelchair moving when climbing. If you need to stop, restart slowly and speed up carefully.



WARNING! Please drive down a slope at the minimum speed. If the descent speed is faster than expected, release the joystick lever to stop the wheelchair, and then press the lever lightly to control the descent speed.



WARNING! The recommended maximum climbing angle (see parameter table) was tested in a controlled environment. Your wheelchair's ability to climb is affected by factors such as your weight, the speed of your wheelchair, and the angle at which you approach the slope.



WARNING! Reversing is only possible on flat roads. When reversing, please operate smoothly at low speed. Please stop frequently and check to make sure there are no obstacles on the road. To prevent rollover, do not tilt down or backward along the slope.



WARNING! When sitting in a wheelchair, avoid any position or movement that can change your center of gravity. This may cause the wheelchair to tilt.



WARNING! Do not put all the weight on one side of the wheelchair deck, such use may cause the wheelchair to tilt.

WARNING! Do not put your hands above the seat or tilt your body. This may damage the backrest and cause you to fall down.



WARNING! Even if your wheelchair can cross high obstacles, we recommend that you do not try to cross a height exceeding 25mm. Such operations may cause the wheelchair to be unstable. Riding a wheelchair over an obstacle of such height can cause a rollover and severe personal injury. If you have any concerns about safely crossing obstacles, please ask for help. Please pay ATTENTION to your operating skills and personal restrictions. You may need to remove or cover the sills and install ramps at exits and entrances.



WARNING! Do not attempt to climb over obstacles on slopes.  
WARNING! Do not rely on a wheel to get over obstacles.



WARNING! Never operate the wheelchair near railroad tracks or crossings.



WARNING! Do not drive the wheelchair along the edge of a stream, lake or sea. Please do not drive the wheelchair across the water.



WARNING! Do not expose wheelchair to open flames.



ATTENTION! Keep your wheelchair in a dry and clean environment. Don't take the wheelchair to shower, bath, pool or sauna. Rain, snow, salt, fog / spray conditions and frozen / smooth surfaces can cause wheelchair screws and some fixtures to rust untimely.



ATTENTION! Avoid prolonged exposure to excessively hot and cold environments; it may damage the cushioned and non-cushioned parts of the wheelchair as well as the battery and battery components.



ATTENTION! Do not drag the wheelchair. Dragging may exceed its own speed threshold, causing damage to key parts of the wheelchair.



ATTENTION! Be extremely careful when moving an idle wheelchair up and down the stairs. The wheelchair must be folded, requiring the participation of several physically capable people.



WARNING! Do not cross stairs or escalators with the wheelchair.



WARNING! Do not sit on a wheelchair while it is in any transport vehicles.



WARNING! For safer handling: Always keep the power off before moving. Failure to do so may result in touching the joystick and causing the wheelchair to move unexpectedly. Make sure the brakes are locked so to prevent the wheelchair from moving during handling. This wheelchair could be driven into the elevator, while you must turn off the power and sit firmly to ensure that the wheelchair will not move after entering the elevator.



WARNING! Do not place the wheelchair on the front seat of the vehicle during transportation, it may move and disturb the driver.



ATTENTION! Please contact your service provider if any spare parts on the seating system are loose. Replace worn or damaged padding immediately.



**WARNING!**Radio wave sources, such as radio stations, television stations, amateur radio transmissions, two-way radios and mobile phones can affect wheelchair control.

The following WARNINGS should reduce the possibility of severe injury due to accidental braking or movement of the power wheelchair:

1. Do not turn on portable personal communication devices, such as citizen band (CB) radios and mobile phones when the power wheelchair is powered on;
2. Pay attention to nearby transmitters, such as radio or television stations, and try to avoid approaching them.
3. In the event of unexpected movement or brake release, the power wheelchair should be turned off as soon as possible under safe conditions;
4. Please note that adding accessories or parts, or modifying power wheelchairs may make it more susceptible to interference from radio wave sources (note: there is no easy way to assess the influences of above modifications on the wheelchair's overall immunity from radio wave sources); and report to the power wheelchair manufacturer of all accidents of unexpected movement or brake release, and pay attention to nearby radio sources and other important information.

### 3. Performance and Structure

#### 3.1 Product Structure

Your wheelchair is mainly composed of backrest, seat cushion, battery, joystick, armrest, front wheel, drive wheel, motor, brake lever, anti-tipper, foot rest and frame etc.

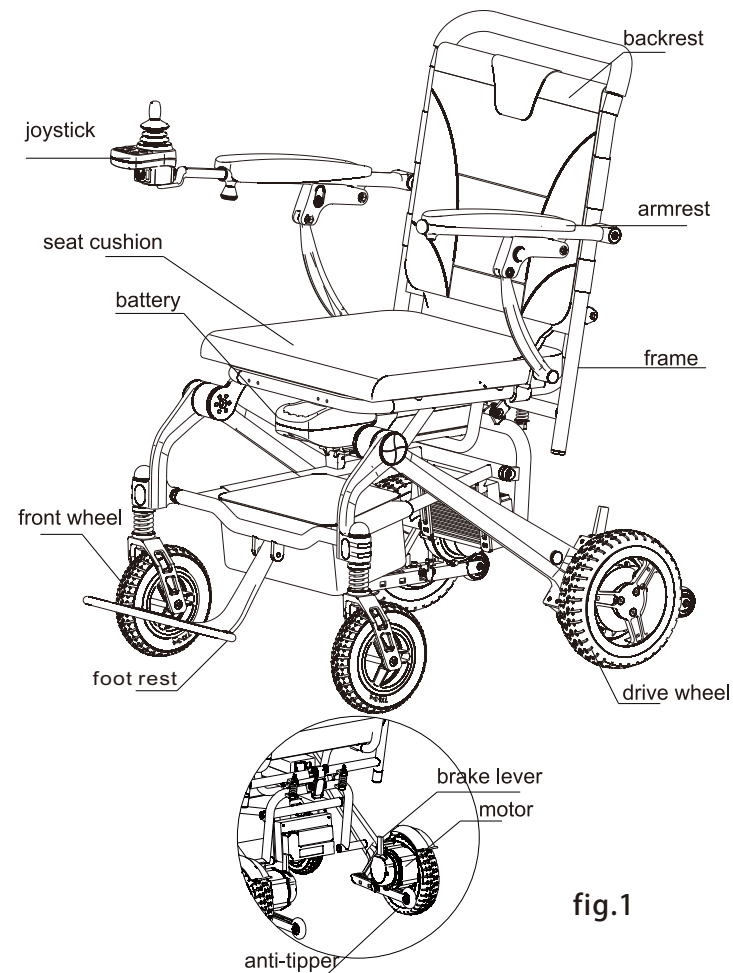

fig.1

Overall Dimension	940x610x960 mm
Folded Dimension	720x310x610 mm
Seat Height	500 mm
Seat width	380 mm
Effective seat width	500 mm
Backrest Height	480 mm
Weight of Wheelchair	18 kg (Not including the battery)
Battery weight	1.8kg
Maximum Speed	6 km/h
Braking Distance on horizontal road	≤1500 mm
Minimum Turning Radius	≤900 mm
Maximum Load Capacity	136kg(300lbs)
Theoretical Driving Distance	≥15km
Climbing Ability	≥6° (<10°)
Motor Model	24V/250W *2 pcs
Lithium Battery Specification	24V/12Ah
Maximum Output Current of Controller	35A
Maximum Output Current of Charger	2A
Front Wheel Specification	Solid Tyre, 178mm
Rear Wheel Specifications	Solid Tyre, 216mm

#### 4. ASSEMBLY/FOLDING/ADJUSTING

##### 4.1 Assembling

Open the packing box, take out the whole wheelchair, and remove the protective cushion. Firstly pull the footrest forward, then hold the backrest with one hand and hold the seat with another hand to pull the wheelchair forward and backward. When you hear "click", it indicates that the latch has been stuck into the locking pin (Fig. 2), and the wheelchair has been unfolded. (Fig. 3).

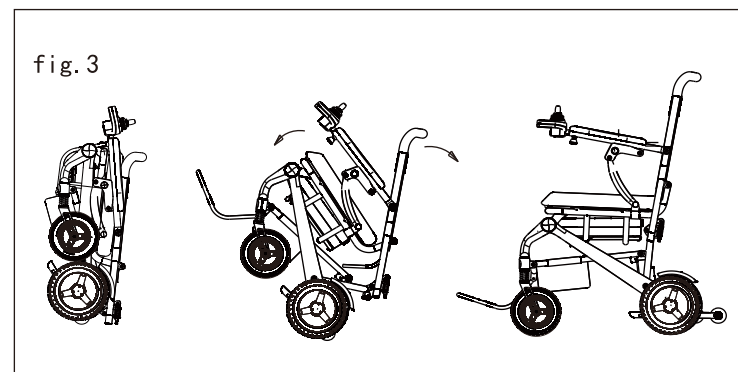
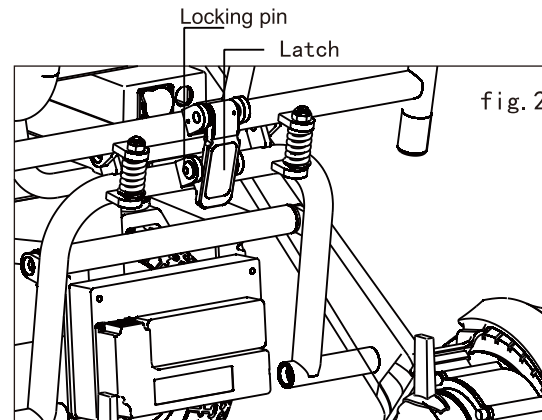



**WARNING!**  
 After unfolding the wheelchair, it is necessary to check whether the latch has been stuck into the locking pin. And then you can sit on it only after the latch is fixed. Otherwise, it will damage the wheelchair and cause personal injury.

**4.2 Adjusting**

The joystick can be adjusted to most comfortable position according to the user's height and arm length. When adjusting it, please loosen the knob of the armrest and then the joystick shall be stretched. When stretched at your most comfortable position, the joystick shall be firmly locked after the knob tightened.(Fig.4).

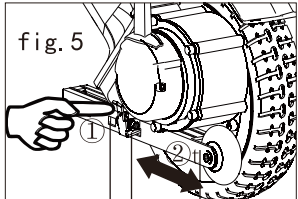
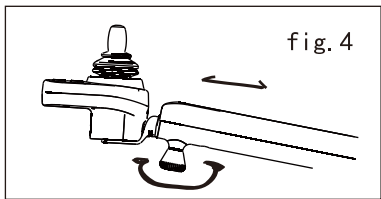

Position Limit Hole      Anti-tipping Holder  
 Anti-tipper Latch

**Adjusting Anti-tipper**

Anti-tipper is a safety device to prevent the wheelchair from turning over when driving on the slope(Fig.5). When you only need to use on indoor flat surfaces, retract the tilting wheel holder inwards. When need to drive on a slope, you must extend the anti-tipper to the outermost gear. When adjusting, just press down the latch of anti-tipper holder by hand ① that can move inward or outward ②. Put the latch into the position limit hole (3)when the position is confirmed.

**WARNING!**  If wheelchair tipped backward, it will cause serious injury. So, properly using anti-tippers can reduce the risk of tipping.

**4.2.3 Adjusting brake lever**

Each motor has one brake lever. When the lever is pushed at location A, the wheelchair will be in electric mode, which will only be operated by power. When the lever at location B, the wheelchair will be in manual mode, which will only be pushed by hand.(Fig. 6)

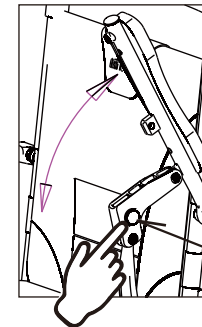
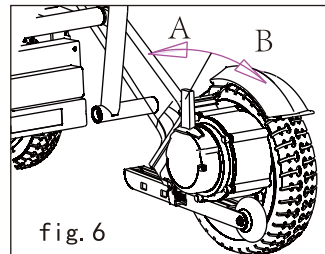



fig. 7

Armrest Locking Knob

**WARNING!**  
 When the wheelchair is in manual mode, do not use your wheelchair unless getting help from your assistant. Otherwise it may result in personal injury. Do not set your wheelchair in manual mode when it is on an incline. Otherwise, the wheelchair could be out of control and may roll by itself, and result in personal injury.

**4.2.4 Adjusting Armrests**

For the convenience of getting on/off the wheelchair for people who have trouble with walking, the armrest of this product can be flipped up. To flip up the armrest, just press the lock button under the armrest, flipping upward (Fig.7). To flip down the armrest, just press downward the armrest, when you hear the "click" sound, indicating that the armrest has is locked into place. The armrest is reset now.

### 4.3 Folding

If the wheelchair needs to be folded, please pull up the latch at the rear of the wheelchair body(Fig.8), meanwhile flip up the seat cushion, then the wheelchair could be folded. With the wheelchair body folded in place, flip up the footrest. (Fig.9)

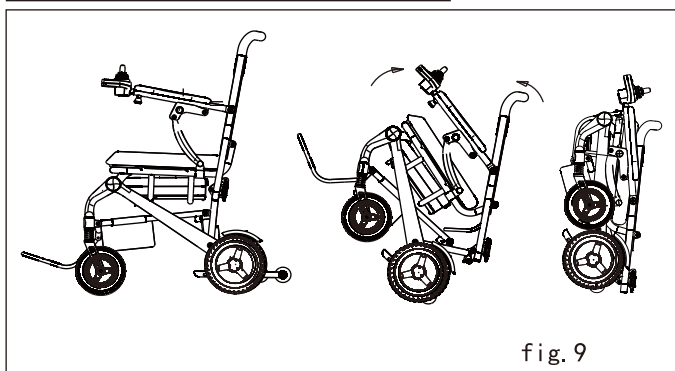
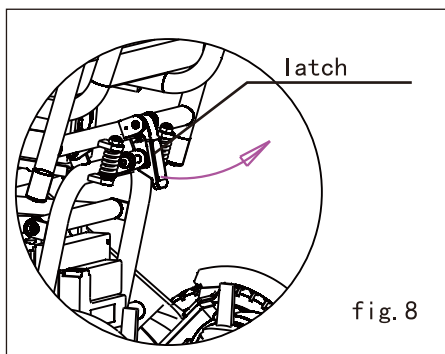

When the wheelchair stands up after folded, The footrest could be fastened by tape to avoid it flipping down.

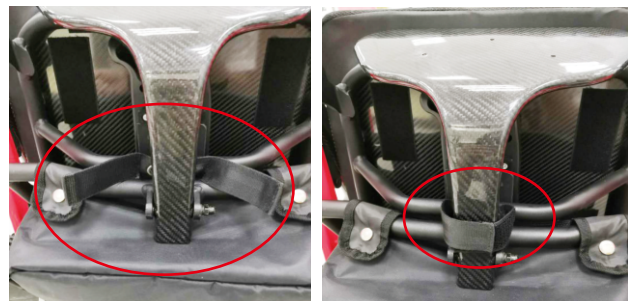

## 5. USE AND OPERATION

### 5.1 Joystick

5.1.1 All the electric components to control the wheelchair are integrated to the joystick, including (1) power switch, (2)battery indicator, (3)speed indicator, (4)speed down button,(5)speed up button, (6)joystick lever, (7)horn button. You can implement all the operations of this wheelchair the above buttons. (Fig.10)

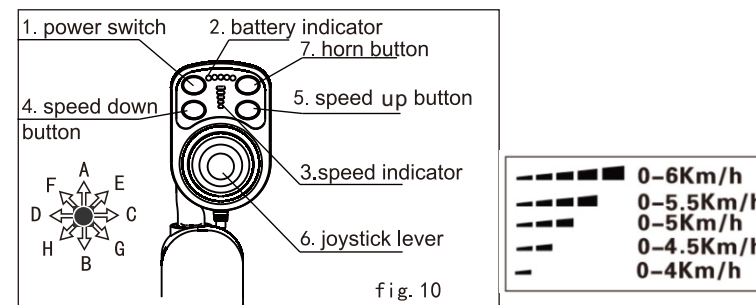

5.1.2 Power switch (1): It is the switch to supply power to the control system. Press the power switch to turn the power on. the power indicator light (2)and speed indicator light(3) will be on. Press it again, the power is off, then the power indicator light(2)as well as the speed indicator light (3)will go out.

5.1.3 Speed down button(4): After turning on the power, the speed indicator(3) displays the current maximum driving speed,and will decrease by one bar with each press on it. The number of displayed bars represents the current maximum speed. The range could be adjusted by the user.

5.1.4 Speed up button(5): After turning on the power, the speed indicator(3) displays the current minimum driving speed,and will increase by one bar with each press on it. The number of displayed bars represents the current maximum speed. The range could be adjusted by the user.

5.1.5 Battery indicator(2): It displays the battery storage. All bars lit : power is sufficient; 3-4 bars displayed indicates the power is ok. Lower than 2 bars indicates lack of power and the battery needs to be charged.

5.1.6 Joystick lever(6): The main function of the joystick is to control the direction and speed of wheelchair. The wheelchair would move forward if the joystick is in position A (fig 10); move backward move joystick to position B; turn to left or right if turn to C or D in situ; move forward and left or right if push to E or F; move backward and left or right if push to G or H. The further the joystick is pushed from its central position, the faster the wheelchair moves. When it is released, it will automatically reset and brake.



**WARNING!** Avoid any accessories that may intervene the operation of joystick. Otherwise, the wheelchair may move accidentally.

## 5.2 Charging

### 5.2.1 Charge the batteries with off-board charger

Be certain that the wheelchair is powered off. Connect the output plug of the charger to the 3-hole socket on the battery pack from the back of the wheelchair;(Fig.11)  
Connect the input plug to standard power outlet.

The red indicating light on the charger lights represents the charging is in progress;  
The green indicating light is turned on when the batteries are basically fully charged, then please keep charging for 1-2 hours; We recommend to charge the batteries for 6-8 hours; Remove the power plug and charger when the batteries are fully charged.

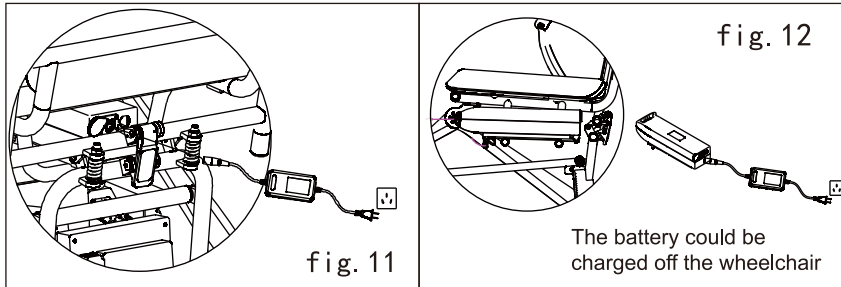

### 5.2.2 Initial use of new batteries

To maximize the efficiency of batteries, please note below

- Fully charge your new battery prior to its initial use. This brings the battery up to about 90% of its peak performance level.
- After four or five charging cycles, the batteries will top off at 100% charge and also extends its lifespan.

### 5.2.3 Charging the battery off wheelchair

Release the buckle which holds the battery pack underneath the seat; hold the handle of battery pack and pull it out forward; connect the output plug of charger to the 3-hole socket of battery pack; connect the input plug of charger to the standard power outlet.(220V) (Fig.12)

### 5.3 Battery replacement

If the battery needs to be replaced, release the battery pack buckle underneath the seat then take it out. The battery must be in accordance with below specification:

Type	Lithium Battery
Dimension	320*80*65mm
Voltage	24V

### 5.2.4 Connect the 3-pin metal plug of the charger into the 3-hole charger socket on the controller(see fig.13).

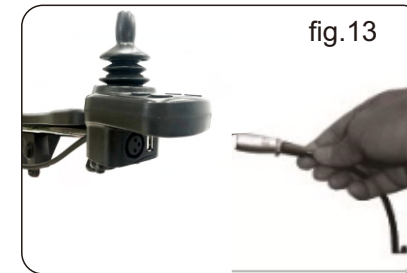

### 5.2.5 Safety Belt

For your safety on the way, you have to fasten the safety belt whenever you seat on the wheelchair.

Snap the belt buckle so to hear a click (fig. 14)

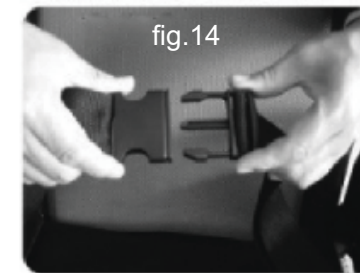







**WARNING!** Please do not operate the wheelchair while charging.



**ATTENTION!** Please do not mix up the new and used batteries.  
**ATTENTION!** Please replace with battery of same type, chemical substances and capacity. Please select the battery type and capacity per specification in the manual. Please use the replacement battery directly provided by the authorized supplier(s) to ensure the performance and function.



**ATTENTION!** Please protect the battery from freezing; Please do not charge the frozen battery, otherwise the battery may be damaged.

	Prohibited! Removal of grounding prong can create electrical hazard. If necessary, properly install an approved 3-pronged adaptor to an electrical outlet having 2-pronged plug access
	Prohibited! Never use an extension cord to plug in your battery charger. Plug the charger directly into a properly wired standard electrical outlet.
	Prohibited! Do not allow unsupervised children to play near the travel scooter while the batteries are charging. We recommend that you do not charge the batteries while the travel scooter is occupied.
	Mandatory! Read the battery charging instructions in this manual and in the manual supplied with the battery charger before charging the batteries.
	Warning! Explosive gases may be generated while charging the batteries. Keep the travel scooter and battery charger away from sources of ignition such as flames or sparks and provide adequate ventilation when charging the batteries.
	Warning! Inspect the battery charger, wiring, and connectors for damage before each use. Contact your authorized provider if damage is found.
	Warning! Do not attempt to open the battery charger case/battery case. If the battery charger does not appear to be working correctly, contact your authorized provider. If the battery charger is equipped with cooling slots, then do not attempt to insert objects through these slots. Be aware that the battery charger case may become hot during charging. Avoid skin contact and do not place on surfaces that may be affected by heat.
	Warning! If your battery charger has not been tested and approved for outdoor use, then do not expose it to adverse or extreme weather conditions. If the battery charger is exposed to adverse or extreme weather conditions, then it must be allowed to adjust to the difference in environmental conditions before use indoors. Refer to the manual supplied with the battery charger for more information.

## 6. GENERAL GUIDANCE

- 6.1 Avoid knocking or hitting the control units;  
6.2 Avoid prolonged exposure of your wheelchair to extreme conditions, such as hot, cold or moist environment; keep the controller clean.  
6.3 Check all connections, and ensure that they are all tight and secure.  
6.4 Check all cable connections, including the cable connection of the charger. Make sure they are firmly fastened and not corroded. The battery pack must be correctly installed into the slide rail.  
6.5 After each use, the power switch should be turned off in time to reduce unnecessary consumption of the battery.  
6.6 The wheelchair has power-saving function. If no operation to the wheelchair within 20 minutes, the controller would cut off the power automatically. If need to continue operating this wheelchair, please turn it on again.  
6.7 All wheel bearings are lubricated and sealed. No need to lubricate them.  
6.8 In order to keep the wheelchair always in good condition, you should check it before each use and keep weekly, monthly and semi-annual check. See table 2 for the inspection items and times.

Table 2

Inspection Items	At any time	Weekly	Monthly	Semi-annual
Each part			⊙	
Turning, driving, setting, dismantlement, etc		⊙		
brake	⊙			
Connecting lines		⊙		
Battery condition	⊙			
Tire Condition			⊙	
Motor				⊙
Devices		⊙		
Cleanliness	⊙			

## 7. FAULT ANALYSIS AND TROUBLESHOOTING

For your convenience, this wheelchair is equipped with a malfunction auto alarm. Once it is out of order, the LED lights on the controller will flash with alarm sounded by the horn. You can find where a fault is according to information in Table 3. If the fault still exists after checking according to table 3, Please consult with your service agent.

Beep 2+1	Communication failure	Check connection inside the joystick
Beep 2+2	Right motor failure	Check right motor or wire connection
Beep 2+3	Right brake error or cable connection poor	Check if the brake lever is in place & if the brake is damaged
Beep 2+4	Left motor failure	Check left motor or wire connection
Beep 2+5	Left brake error or cable connection poor	Check if the brake lever is in place & if the brake is damaged
Beep 2+6	Overcurrent	Check if the motor is locked or short circuit or if the joystick is damaged
Beep 2+7	Joystick lever failure	Check if the joystick lever works normally or the inside connection is loose
Beep 2+8	Joystick failure	Check with supplier for repair
Beep 2+9	Battery failure	Charge the battery, if still not work, replace a new battery with same specification

### ATTENTION!



In order to ensure the quality of wheelchair, during the maintenance, if any consumable parts such as battery, wheels, joystick, motor/actuator and charger need to be replaced, please contact this company or dealer, replacing the original parts of same model and specification.

## 8. TRANSPORTATION AND STORAGE

### 8.1 Transportation

You can load and transport according to the shipping marks and graphics on cartons. For details, see the attachment.

### 8.2 Storage

Your wheelchair should be stored in a clean indoor environment with relative humidity  $\leq 80\%$ , good ventilation and free from corrosive gas. Remove the battery from the wheelchair prior to storage. Otherwise, the frame may rust and the electronics may be damaged.

## 9. OPENING AND CHECKING

The packing list is attached in the package. Please check if any parts are missing or damaged.

No.	Name	Qty	Remarks
1	Power Wheelchair	1 pc	JAZZY CARBON
2	Charger	1 pc	Model: AC100-240V50/60HZ24 V 2A
3	Manual	1 pc	
4	Joystick	1 pc	
5	Battery	1 pc	

## 10. Quality Assurance

### 10.1 Warranty

#### 10.2.1 Lifetime warranty on frame

10.2.2 Within 1 year from the purchase date, for the following parts, we will supply free maintenance and replace service for original customer after the dealer check there are materials and production defect.

Electrical control or lever system

Motor/Drive System

Bearing and shaft sleeve

Battery

Please note the warranty service is provided by your dealer, and finally finished by our after-sales department and dealer together.

### Out of warranty

ABS plastic cover shell and rubber pad

Tyre

Interior decoration & cushion

Damage by abuse, wrong operation, accidents and negligence

Damage by wrong maintenance and storage

Business use or other abnormal use



**Manufacturer :**

ZHEJIANG INNUOVO REHABILITATION DEVICES CO.,LTD  
No.196 Industry Road, Hengdian Movie Zone, Dongyang, Zhejiang, China.

**EU Authorized Representative :**

SUNGO Europe B.V.  
Olympisch Stadion 24, 1076DE Amsterdam, Netherlands.

**Distributor :**

**Pride Mobility Products Europe BV**  
De Zwaan 3  
1601 MS Enkhuizen  
The Netherlands  
[www.pridemobility.eu](http://www.pridemobility.eu)  
[www.pride-mobility.nl](http://www.pride-mobility.nl)

**Pride Mobility Products Spain SLU**

Calle Minas, 67  
28923 Alcorcón  
Madrid  
Spain  
[www.pridemobility.es](http://www.pridemobility.es)

**Pride Mobility Products GmbH**

Hövelrieger Str. 28  
D-33161 Hövelhof  
Germany  
[www.pridemobility.de](http://www.pridemobility.de)

**Pride Mobility Products France**

26 Rue Monseigneur Ancel  
69800 Saint-Priest  
France  
[www.pridemobility.fr](http://www.pridemobility.fr)

**Pride Mobility Products Ltd**

32 Wedgwood Road  
Bicester, Oxfordshire  
OX26 4UL UK  
[www.pride-mobility.co.uk](http://www.pride-mobility.co.uk)

**Pride Mobility Products Canada**

5096 South Service Rd.  
Beamsville, Ontario, L3J 1V4  
Main office 1-888-570-1113  
[www.pridemobility.ca](http://www.pridemobility.ca)

Serial number: